

# AMERICAN PRO STRATOCASTER® HSS (0113040000)

## PARTS LAYOUT

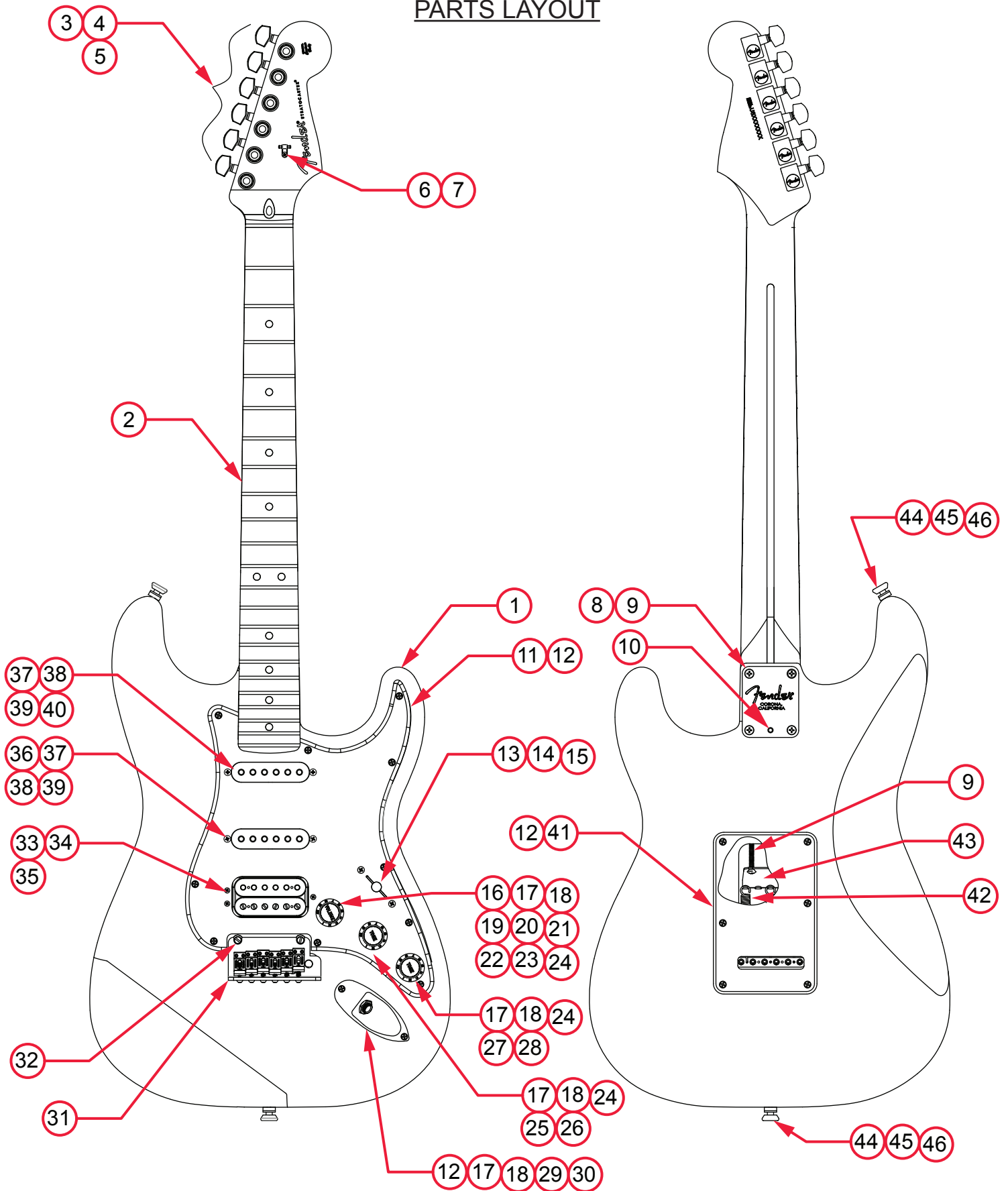

# AMERICAN PRO STRATOCASTER® HSS (0113040000)

## PARTS LIST

REF#	DESCRIPTION	PART NUMBER
1	BODY AM PRO STRAT 3TS	0054014500
1	BODY AM PRO STRAT OWT	0056229505
1	BODY AM PRO STRAT BLK	0056229506
1	BODY AM PRO STRAT SNG	0056229548
1	BODY AM PRO STRAT ATO	0056229576
1	BODY AM PRO STRAT SSB	0054015547
2	NECK ASSY AM PRO STRAT RW	7709880000
2	NECK ASSY AM PRO STRAT MPL	7709881000
3	KEYS 2 PIN MOUNT SET W/HARDWARE	0990820100
4	KEY WASHER	0053106049
5	KEY BUSHING	0058820049
6	STRING TREE W/HARDWARE	0994911000
7	SCREW SMAB 3 X 3/8 RHP STL NI	0011357049
8	NECK PLATE CORONA CA TILT W/HARDWARE	0991445100
9	SCREW SMA 8 X 1-3/4 OHP NI	0015636049
10	SET SCREW 1/4-20 X 3/8 OP NI HEX	0031571000
11	PICKGUARD STRAT HSS P/B/P	0056799000
11	PICKGUARD STRAT HSS MG/BLK/MG	0054021000
12	SCREW SMAB 4 X 1/2 OHP NI	0015578049
13	SWITCH 5-WAY LEVER DISCRETE/COM	0078776000
14	SCREW MA 6-32 X 5/8 RHP NI	0021417049
15	KNOB PICKUP SWITCH VINT AGED WHITE	0994938000
16	CONTROL 500K/250K SPLIT 3/8 BUSH	7707211000
17	NUT HEX 3/8-32 X 3/32	0016352049
18	WASHER LCK INTNL 3/8 X 500 X .02 NI	0022384049
19	CAPACITOR CD 1000pF 1000V 10%	0060962000
20	CAPACITOR CD 1200pF 1000V 10%	0065862000
21	RESISTOR CF 1/4W 270K 5%	0029006001
22	RESISTOR CF 1/4W 150K 5%	0024999001
23	RESISTOR CF 1/4W 20K 5%	0029006001
24	KNOBS STRAT 1-VOL 2-TONE AGED WHITE	0991369000
25	CONTROL 250K 10% TPR SPLIT	0990830000
26	CAPACITOR MPF RDL .05MF 100V 10%	0015552049
27	CONTROL 500K VOL 3/8 SPLITT CTS	0990834000
28	CAPACITOR MPF RDL .022µF 250V 10%	0024832049

\*= NOT PICTURED IN DIAGRAM



# AMERICAN PRO STRATOCASTER® HSS (0113040000)

REF#	DESCRIPTION	PART NUMBER
29	FERRULE JACK CHROME	0991940000
30	JACK PHONE OPEN CIRCUIT 11	0021956049
31	BRIDGE ASSY AM PRO STRAT	7709950000
31A	BRIDGE PLATE TREM AM PRO STRAT CHROME	7709899000
31B	BLOCK TREMOLO AM DLX STRAT RH SILVER MET	0077090000
31C	BRIDGE SECTION ASSY NI AS STRAT SHORT	0075123101
31D	BRIDGE SECTION ASSY NI AS STRAT TALL	0075123102
31E	SPRING BRIDGE #1932	0019281049
31F	SCREW M 4-40 X 5/8 RHP NI	0015693049
31G	SCREW M 8-32 X 3/8 FHP NI	0019656049
31H	SPRING CLIP ULTRA	0036531000
31I	BUSHING NYL NAT .31 OD X .191 ID X .87 L	7710005000
31J	SET SCREW 10-32 X 3/16 HEX SKT FP BLX	0036615049
32	BRIDGE PIVOT POST ASSY	0093273000
33	PICKUP ASSY SHAWBUCKER BRIDGE ZEBRA	7707189000
34	SCREWS MACH 3-48 X 13/16 NI	0051596049
35	SPRING HUMB MTG 3/4"	0050167049
36	PICKUP ASSY AM PRO SHAW STRAT MID AGED WHITE	7709890000
37	SCREW TF 6-32 X 3/4 RHP STL NI	0099346000
38	TUBING LATEX CUT .250 OD X .125 ID X .300 L	0994916000
39	COVER PICKUP STRAT VINTAGE AGED WHITE	0053824000
40	PICKUP ASSY AM PRO SHAW STRAT NECK AGED WHITE	7709892000
41	BACK COVER STRAT STD W/SLOT RH MG/BLK/MG	0054029000
41	BACK COVER STRAT STD W/SLOT RH P/B/P	0056212000
42	SPRING TREMOLO TENSION BLX	0018671049
43	TREM CLAW SPRING TENSION ZINC	0010272100
44	STRAP BUTTONS CHROME W/HARDWARE	0063267049
45	FELT WASHERS WHITE	0994930000
45	FELT WASHER BLACK	0994929000
46	WOOD SCREW 6 X 1 OHP NI	0016188049
*	CASE AM ELITE GUITAR	7710537000
*	TREMOLO ARM AM PRO STRAT RH POLISHED SS	7709929000
*	TREMOLO ARM KNOB VINT AGED WHITE	0994933000
*	WRENCH HEX KEY 1/8 (TRUSS ROD ADJUSTMENT / TILT NECK ADJUSTMENT)	0023811049
*	WRENCH HEX KEY .050 (SADDLE HEIGHT ADJUSTMENT)	0018531049

\*= NOT PICTURED IN DIAGRAM



# AMERICAN PRO STRATOCASTER® HSS (0113040000)

## PICKGUARD LAYOUT

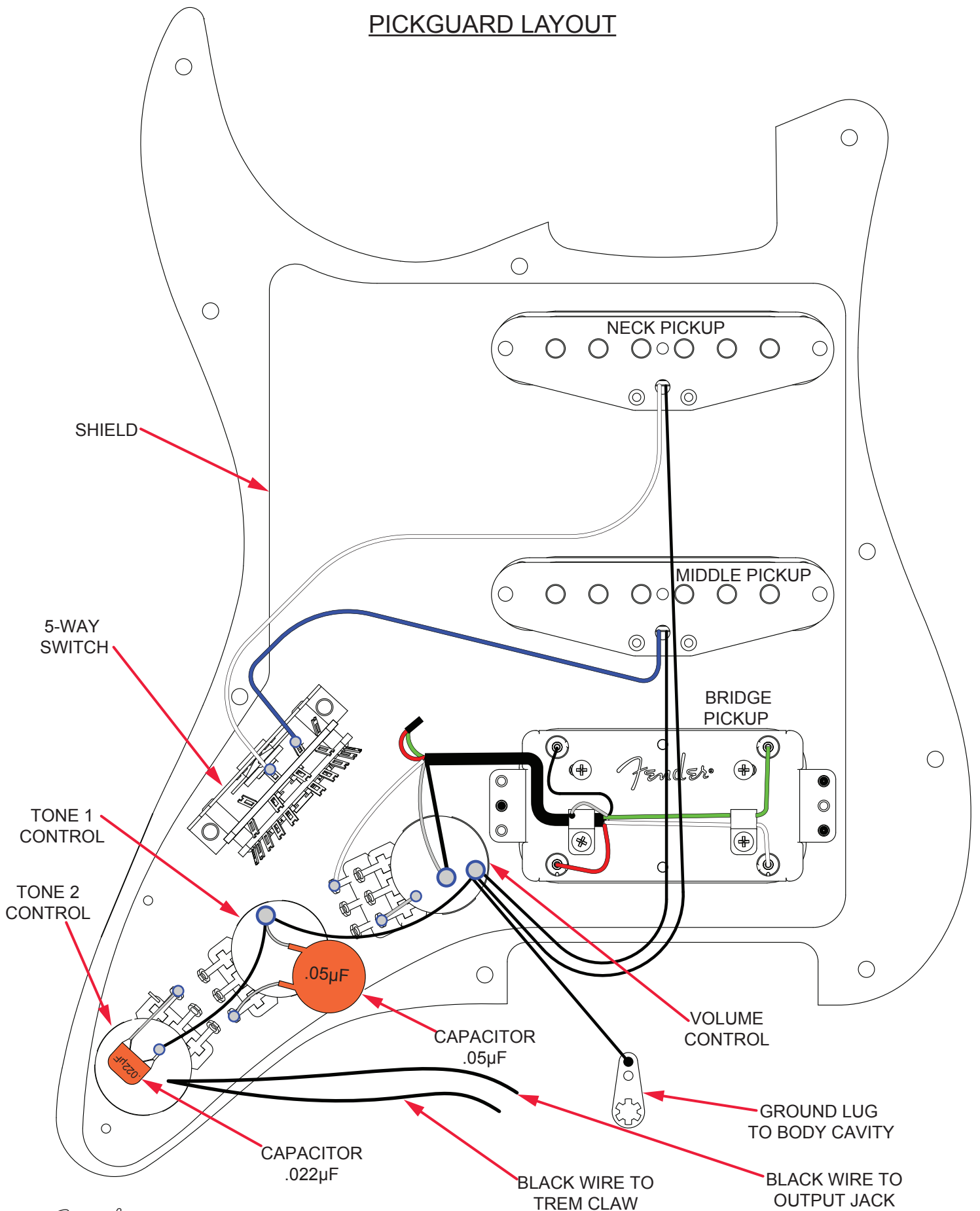

# AMERICAN PRO STRATOCASTER® HSS (0113040000)

## WIRING DIAGRAM

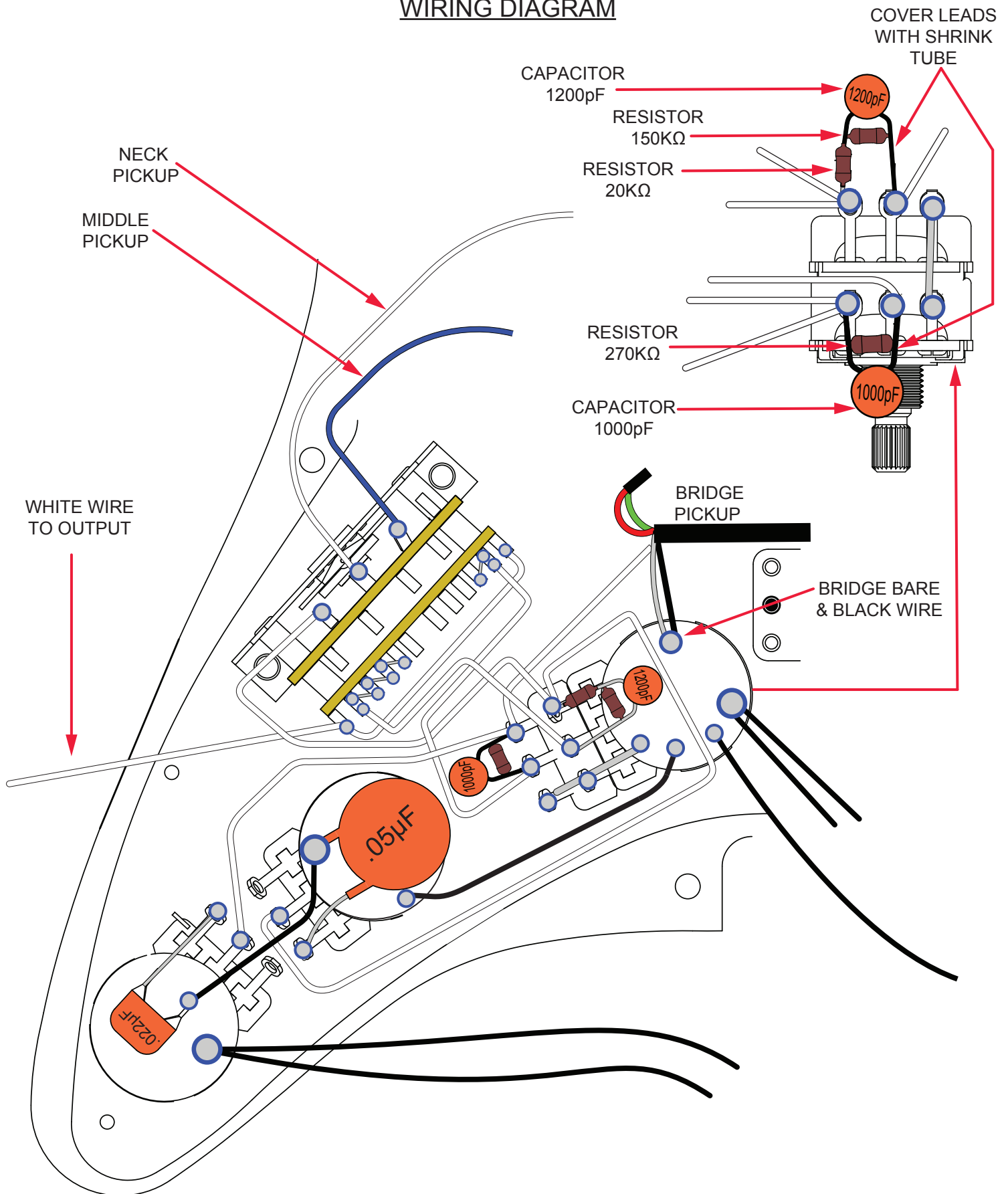

# AMERICAN PRO STRATOCASTER® HSS (0113040000)

## ADDITIONAL SPECIFICATION DETAIL

**FRET SIZE: JUMBO NARROW**  
(FRET DIMENSIONS ARE BEFORE INSTALLATION)

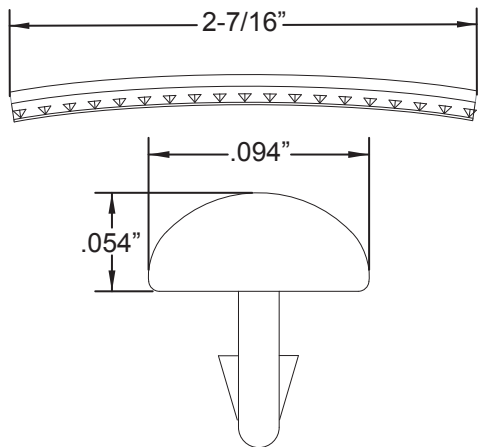

PLEASE NOTE: AS EACH NECK IS SANDED & FINISHED BY HAND, THICKNESS DIMENSIONS MAY VARY SLIGHTLY FROM THOSE SHOWN.

**NECK PROFILE: MODERN DEEP "C"**

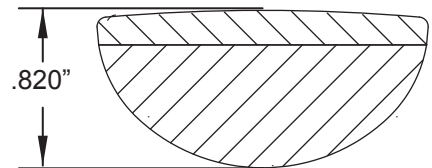

1ST FRET PROFILE

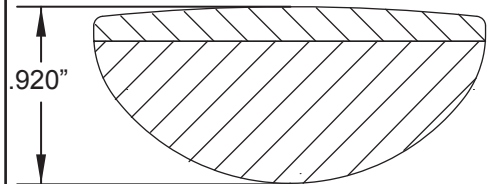

12TH FRET PROFILE

**STAGGERED TUNING MACHINE SET W/HDWR P/N 0990820100**  
**OUTER SHAFT DIAMETER .394"**

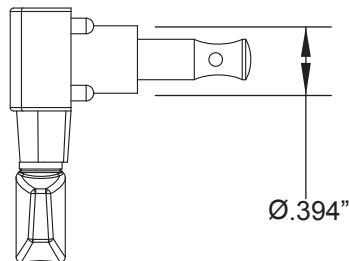

**TUNING MACHINE THRU-HOLE**  
**INNER DIAMETER .404"**

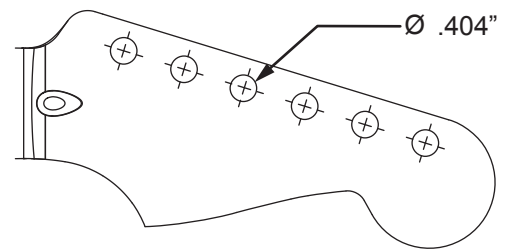

**SADDLE HEIGHT ADJUSTMENT WRENCH:**  
**.050" HEX KEY P/N 0018531049**

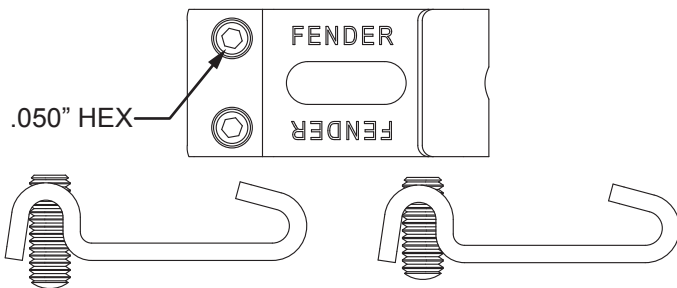

**TRUSS ROD NUT P/N 0994943000**  
**TRUSS ROD ADJUSTMENT WRENCH:**  
**1/8" HEX KEY P/N 0023811049**

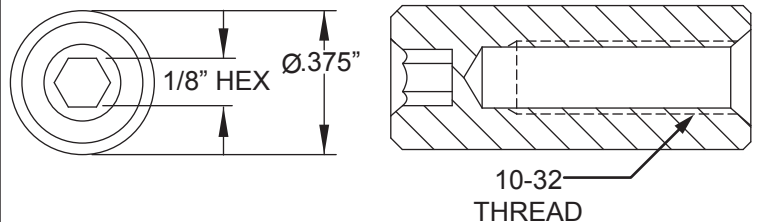

**SADLE HEIGHT ADJUSTMENT SCREWS:**  
**TALL: P/N 0075384000      SHORT: P/N 0075536000**

**LOGO: AMERICAN PRO STRAT**  
**APPLIED UNDER THE FINISH**



### PICKUP SPECIFICATIONS

POSITION	MAGNETS	DC RESISTANCE	POLARITY
NECK	ALNICO 2 & 3	6.1 - 6.7KΩ	SOUTH
MIDDLE	ALNICO 2 & 3	6.4 - 7.0KΩ	NORTH
BRIDGE	ALNICO 2 BAR	7.2 - 7.8KΩ	SOUTH NORTH

# AMERICAN PRO STRATOCASTER® HSS (0113040000)

## SWITCH AND CONTROL FUNCTION

5 WAY SWITCH POSITION					SWITCH POSITION
T1	T1	T1	T1 & T2	T2	← CONTROL
					← NECK PICKUP
					← MIDDLE PICKUP
					← BRIDGE PICKUP
	PICKUP IS ON				
	PICKUP IS OFF				
					INDICATES POSITION OF 5 WAY SWITCH

