

AMERICAN PRO TELECASTER® (011306XXX)

PARTS LAYOUT

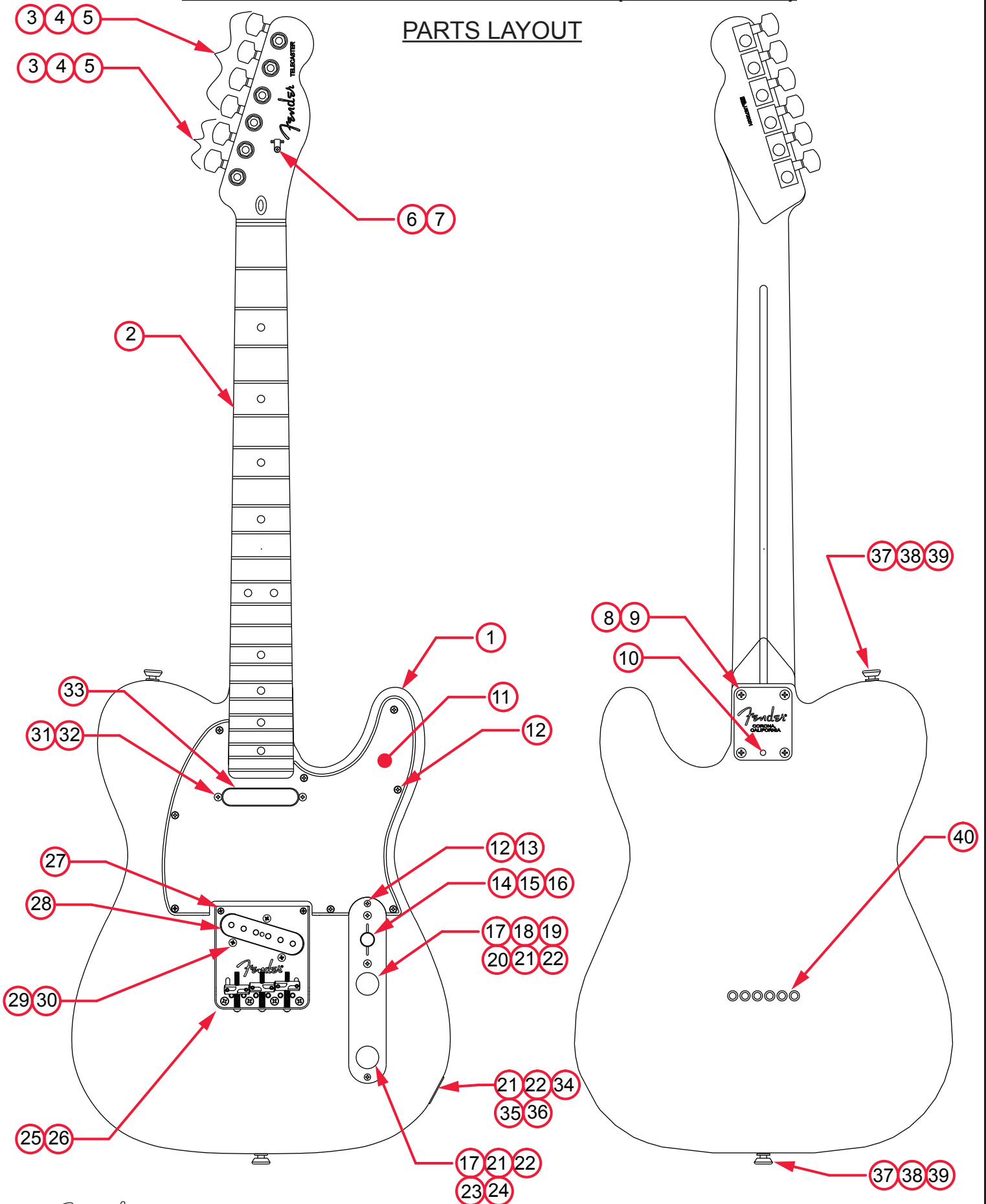

AMERICAN PRO TELECASTER® (011306XXX)

PARTS LIST

REF#	DESCRIPTION	PART NUMBER
1	BODY AM PRO TELE 3TS	7709903500
1	BODY AM PRO TELE 2TS	7709905503
1	BODY AM PRO TELE BLK	7709904506
1	BODY AM PRO TELE NAT	7709905521
1	BODY AM PRO TELE CRT	7709905538
1	BODY AM PRO TELE OWT	7709904505
1	BODY AM PRO TELE SNG	7709904548
1	BODY AM PRO TELE BTB	7709905550
2	NECK ASSY AM PRO TELE RW	7709882000
2	NECK ASSY AM PRO TELE MPL	7709883000
3	KEYS GUITAR 2-PIN MTG SET 2-LONG 4-SHORT W/HARDWARE	0990820100
4	WASHER KEY	0053106049
5	BUSHING KEY	0058820049
6	STRING TREE W/HARDWARE	0994911000
7	SCREW SMAB 3 X 3/8 RHP STL NI	0011357049
8	NECK PLATE CORONA CA TILT W/HARDWARE	0991445100
9	SCREW SMA 8 X 1-3/4 OHP NI	0015636049
10	SET SCREW 1/4-20 X 3/8 OP NI HEX	0031571000
11	PICKGUARD TELE AM STD RH P/B/P	0991375000
11	PICKGUARD TELE AM STD RH 1-PLY BLK	0053191000
11	PICKGUARD TELE AM STD RH MG/BLK/MG	0056083000
11	PICKGUARD TELE AM STD RH B/W/B	0073054000
12	SCREW SMAB 4 X 1/2 OHP NI	0015578049
13	CONTROL PLATE TELE ALUM CHROME	0093823000
14	SWITCH 3 WAY LEVER W/MTL	0992041000
15	KNOB SWITCH VINT TELE	0994936000
16	SCREW MA 6-32 X 5/8 RHP NI	0021417049
17	KNOBS DIAMOND KNURLED ALUM CHROME W/SET SCREW	0095799049
18	CAPACITOR CD 1200pF 1000V 10%	0065862000
19	RESISTOR CF 1/4W 20K 5%	0029006001
20	RESISTOR CF 1/4W 150K 5%	0024999001
21	HEX NUT 3/8-32 X 3/32 TK NI	0016352049
22	WASHER LOCK INTL 3/8 X .687	0016436049
23	CONTROLS 250K 10%	0990831000
24	CAP MPF RDL .022µF 250V 10%	0024832049

*= NOT PICTURED IN DIAGRAM



AMERICAN PRO TELECASTER® (011306XXX)

WIRING ASSEMBLY

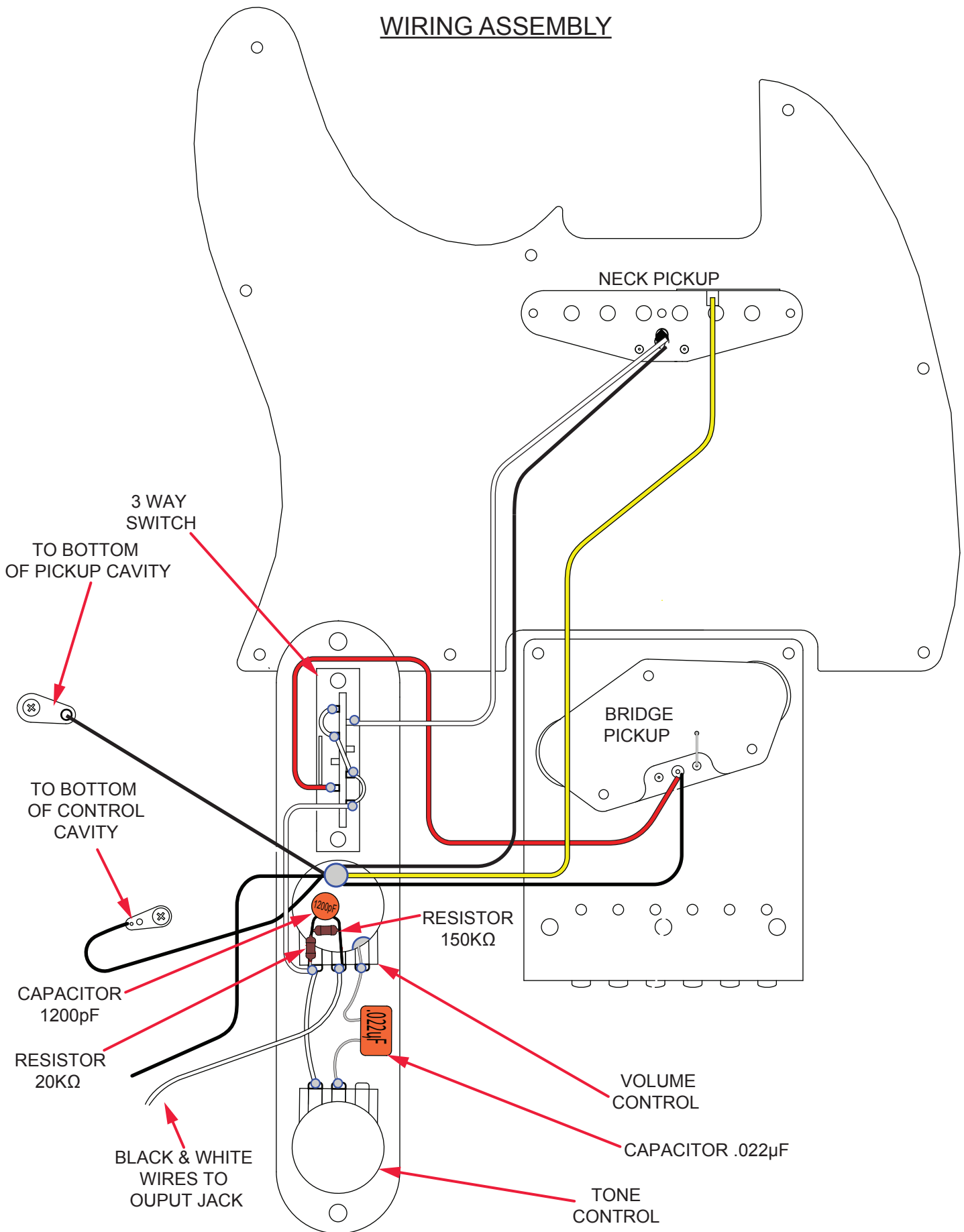

AMERICAN PRO TELECASTER® (011306XXX)

ADDITIONAL SPECIFICATION DETAIL

FRET SIZE: JUMBO NARROW
(FRET DIMENSIONS ARE BEFORE INSTALLATION)

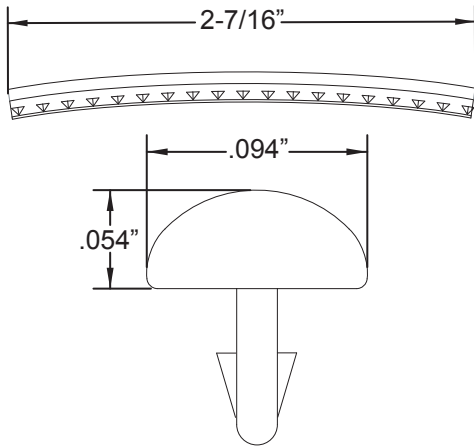

PLEASE NOTE: AS EACH NECK IS SANDED & FINISHED BY HAND, THICKNESS DIMENSIONS MAY VARY SLIGHTLY FROM THOSE SHOWN.

NECK PROFILE: MODERN DEEP "C"

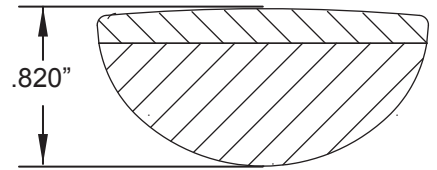

1ST FRET PROFILE

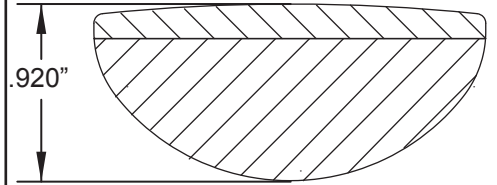

12TH FRET PROFILE

STAGGERED TUNING MACHINE SET W/HDWR P/N 0990820100
OUTER SHAFT DIAMETER .394"

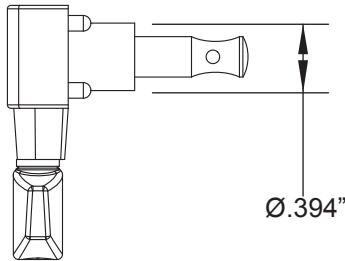

TUNING MACHINE THRU-HOLE
INNER DIAMETER .404"

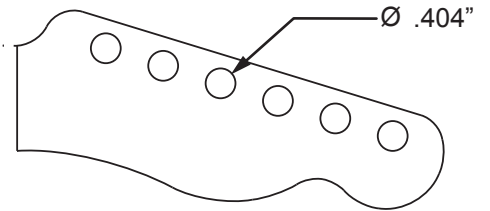

SADDLE HEIGHT ADJUSTMENT WRENCH:
1/16" HEX KEY P/N 0021109049

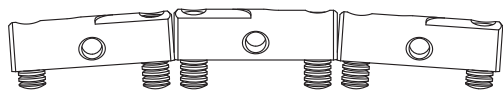
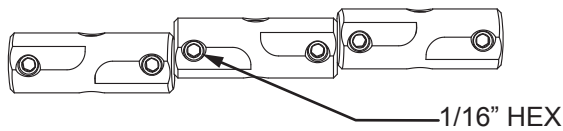

SADDLE HEIGHT SET SCREWS

TALL: P/N 7710428049

SHORT: P/N 7710422049

TRUSS ROD NUT P/N 0994943000
TRUSS ROD ADJUSTMENT WRENCH:
1/8" HEX KEY P/N 0023811049

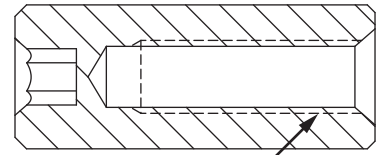
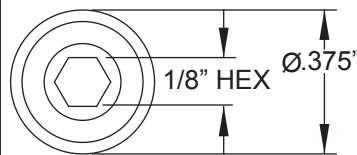

10-32
THREAD

LOGO: AMERICAN PRO TELE
APPLIED UNDER THE FINISH



PICKUP SPECIFICATIONS

POSITION	MAGNETS	DC RESISTANCE	POLARITY
NECK	ALNICO 5 & 2	5.6 - 6.2KΩ	NORTH
BRIDGE	ALNICO 5 & 2	7.2 - 7.8KΩ	SOUTH

AMERICAN PRO TELECASTER® (011306XXX)

SWITCH AND CONTROL FUNCTION

3 WAY SWITCH POSITION			
			← 3 WAY SWITCH POSITION
			← NECK PICKUP
			← BRIDGE PICKUP
	PICKUP IS ON	INDICATES POSITION OF 3 WAY SWITCH 	
	PICKUP IS OFF		

