

**Fender<sup>®</sup>**

THE SOUND THAT CREATES LEGENDS

**Blues Deluxe**

TYPE: PR: 246

**Owner's Manual**

P/N 047013

## Blues Deluxe sound settings

### Classic Blues / Middle or Neck Pickup

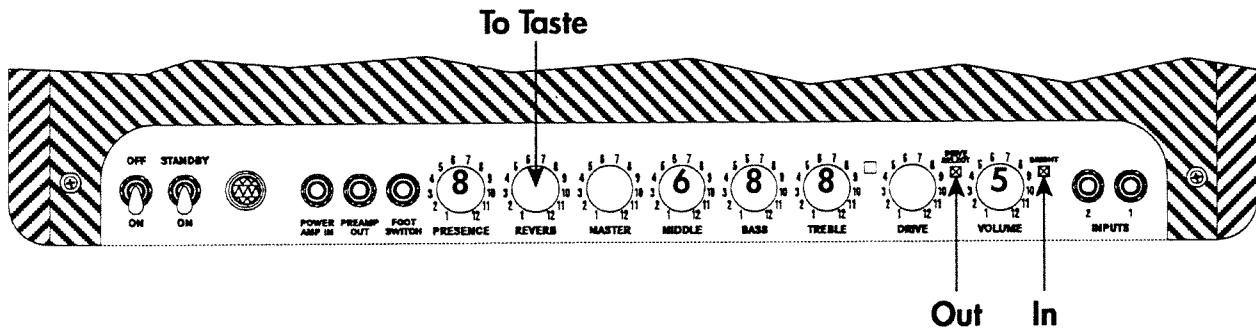

### Tweed with a Bite / Any Pickup Combination

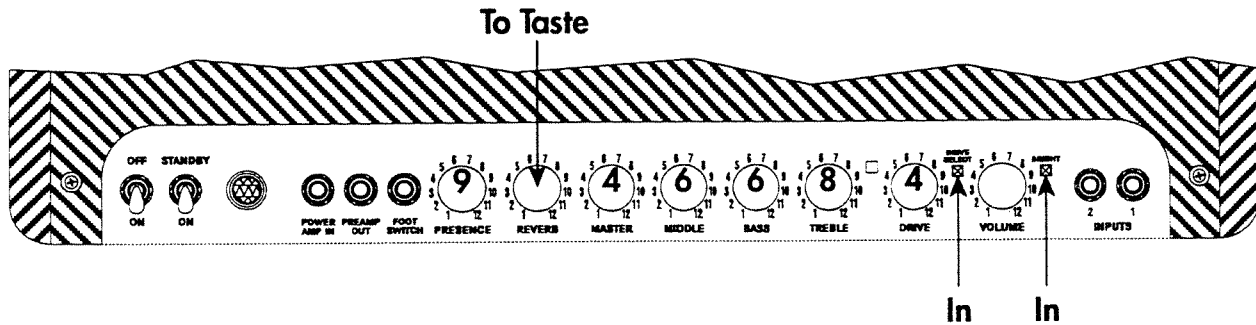

### Sweet Solo / Humbucking Bridge or Middle Pickup

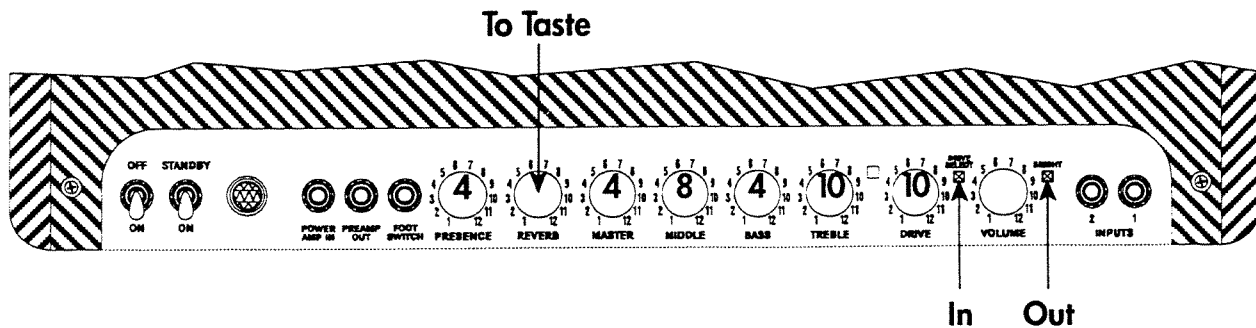

## Introduction

The new **Fender Blues Deluxe** offers classic Fender looks and bluesy sound with useful modern features. For years, the choice of professional musicians has been Fender vintage amplifiers because of their incredibly warm tone and dynamic performance characteristics. Unfortunately, not only are these amps getting harder to find, but, during a performance there is only one sound available. Channel switching didn't exist in the 50's! This is too bad because the old amps have many great sounds available, especially when played LOUD!

Due to the channel switching possible in this amplifier, the **Fender Blues Deluxe** is really two vintage amps in one. The "NORMAL" channel is based on the original tweed BASSMAN circuit of the late 1950's and is capable of delivering every performance characteristic you would expect of that type of amplifier. Even the "Bright" inputs of the BASSMAN have been accommodated by incorporating a bright switch that adds the familiar vintage "sparkle".

The "DRIVE" channel shares the same tone controls as the NORMAL channel but has separate "Drive" and "Master" controls. Using the "Drive" control, the overdrive sound of this channel can be set anywhere from clean and almost identical to the "NORMAL" channel to the sweet, singing, "on ten" BASSMAN sound. The "Master" control can then be used to adjust the overall loudness of this tone. The "DRIVE" channel allows you to have gain and sustain without getting evicted from your neighborhood, or it can be used to supply that extra edge for a solo.

The **Fender Blues Deluxe** features a single 12" vintage re-issue "gold label" speaker.

The **Fender Blues Deluxe** also provides the lush REVERB typical of the Fender Reverb Unit that is commonly used with BASSMAN amplifiers.

The included footswitch allows remote switching between the NORMAL channel and the DRIVE channel.

Preamp Out and Power Amp In jacks provide a signal path for an endless supply of effects devices. Further, using the Preamp Out Jack the **Fender Blues Deluxe's** preamp signal can be sent to an additional guitar power amp, mixing console, etc. Note that if you wish to silence the power amp in the **Fender Blues Deluxe** while doing this, you need to insert a shorting plug into the Power Amp In jack. Also, the **Fender Blues Deluxe's** power amp can be used by another preamp by sending a signal from that preamp to the **Fender Blues Deluxe's** Power Amp In jack.

The 60 Watt tube power amplifier is derived from the BASSMAN and uses a 12AX7A driver for that renowned vintage "soft clip" when the power amplifier is overdriven.

The **Fender Blues Deluxe** consists of a rear-loaded chrome chassis, "Oxblood" grille cloth over the speaker baffle and a cabinet covered in real vintage tweed. Real tweed is used because it's tough and it stands up to travel on the road, just like the amps themselves.

The selection of a Fender amplifier will reward you with years of quality performance and a wide range of musical sounds. This manual is designed to familiarize you with the equipment and to acquaint you with its many features. Please read it carefully so you will benefit from all of the features as soon as you start using the amplifier.

The built-in quality of a Fender amplifier is the result of over four decades of dedication and the combined research and development skills of our musicians and engineers. That is why we proudly say...

**FENDER, The Sound That Creates Legends.**

**WARNING: TO PREVENT FIRE OR SHOCK HAZARD, DO NOT EXPOSE THIS UNIT TO RAIN OR MOISTURE.**

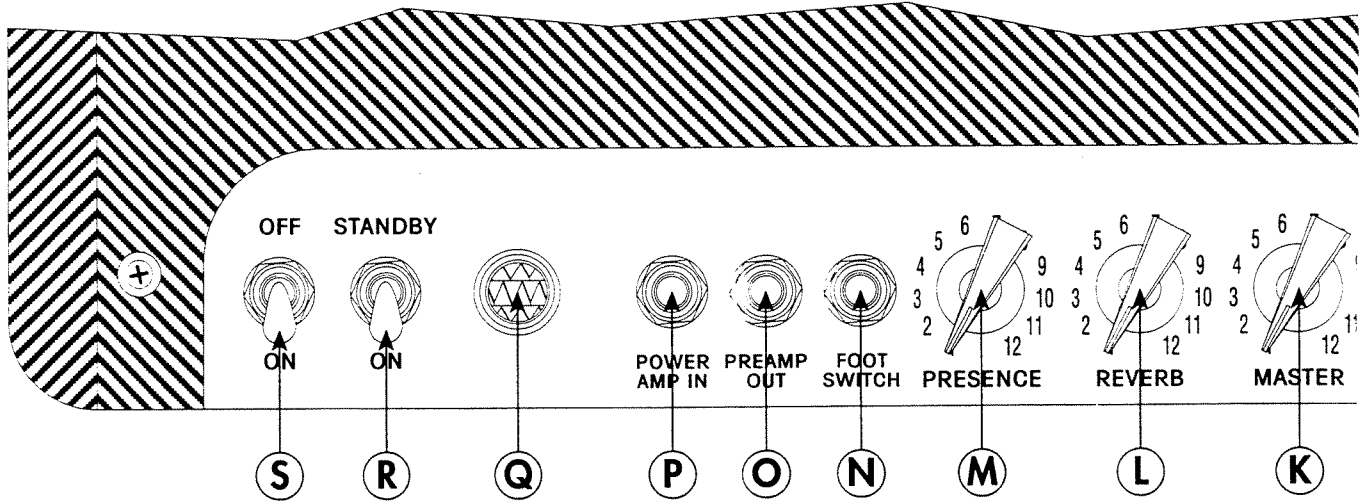

## Blues Deluxe top panel functions

**A. Input 1**-A high impedance, high sensitivity plug-in connection for instruments.

**B. Input 2**-Plug-in connection for instruments. This input exhibits a lower input impedance and sensitivity than INPUT 1 and is useful with active preamp guitars, and will provide a darker tone with passive guitars. Both inputs are identical if used simultaneously.

**C. Bright**-This switch adds a top end brightness to both channels.

**D. Volume**-Adjusts the overall loudness of the Normal Channel.

**E. Drive Select**-When this button is depressed, the amp switches from the Normal channel to the Drive channel.

**F. Drive**-Adjusts the amount of preamp gain in the Drive Channel. Turning this control up will increase the amount of gain and overdrive. This control works in conjunction

with the Master control to set the overall loudness at the output while the drive channel is active.

**G. Drive Channel Indicator**-This LED is illuminated when the Drive Channel is selected.

**H. Treble**-Adjusts the amount of boost or cut in the high frequency range of both channels. Performance Tip: The "Drive" channel is capable of a variety of available sounds. At high gain settings, the drive channel's apparent treble response "comes alive" as the channel generates sustain. With high gain settings, lower treble settings will produce a vintage tone, higher settings will produce a tone with "crunch".

**I. Bass**-Adjusts the amount of boost or cut in the low frequency range of both channels. Performance Tip: When playing at higher volume levels, the tube power amp enhances bass when its overdriven. It may be necessary to use lower bass settings when playing at high volume settings.

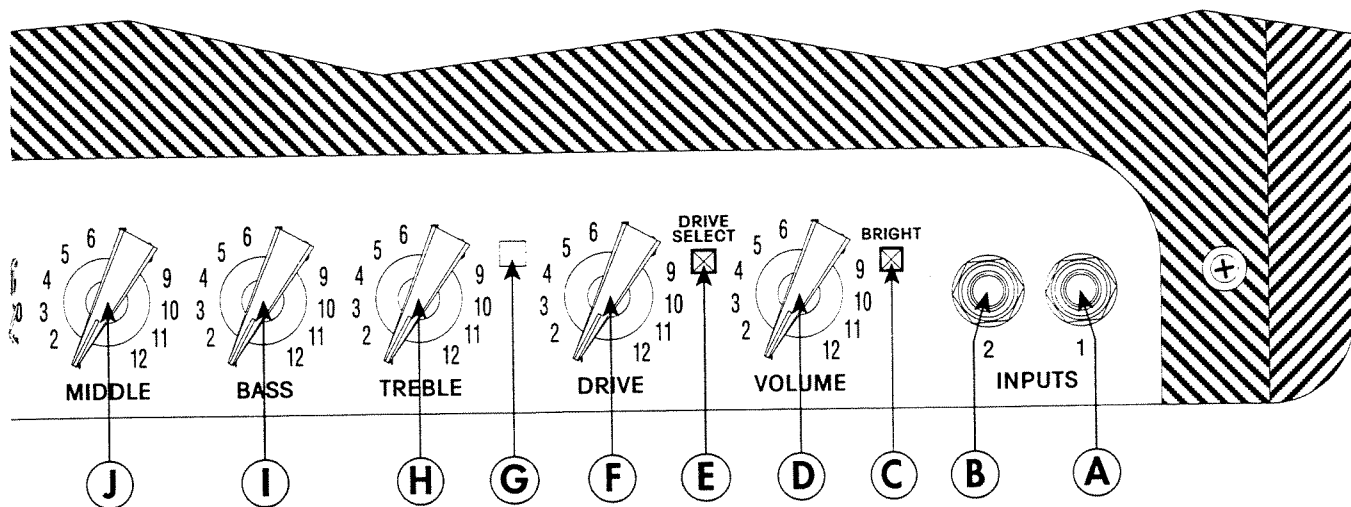

**J. Middle**-Adjusts the amount of boost or cut in the middle frequency range of both channels.

**K. Master**-Adjusts the overall volume in the Drive Channel.

**L. Reverb**-Adjusts the amount of reverb present in both channels.

**M. Presence**-Adjusts the amount of very high frequency content in both channels. This control adds brilliance to the overall tone.

**N. Footswitch**-Plug-in connection for remote footswitch to switch between the Normal Channel and Drive Channel.  
NOTE: Any good quality patch cord will work with the remote footswitch; however, a speaker grade cord is preferable to a coax guitar cord when it's available. Using the footswitch overrides the front panel select button.

**O. Preamp Out**-This jack provides output from the pre-amp, pre-reverb. It is used to patch into effects.

**P. Power Amp In**-This jack provides a return from effects gear into the power amp and is pre-reverb.

**Q. Pilot Light**-This lamp is illuminated when the power is ON.

**R. Standby Switch**-This switch turns the amplifier on and off. In the STANDBY position, the amplifier is off; however, power is applied to the tube filaments so as to eliminate warm-up time, provided the "On/Off" switch (item S) is on. Use of this feature during short breaks versus using the On/Off switch will increase tube life.

**S. On/Off Switch**-Turns the AC power on and off. When the switch is in the off position, the amplifier is completely shut down.

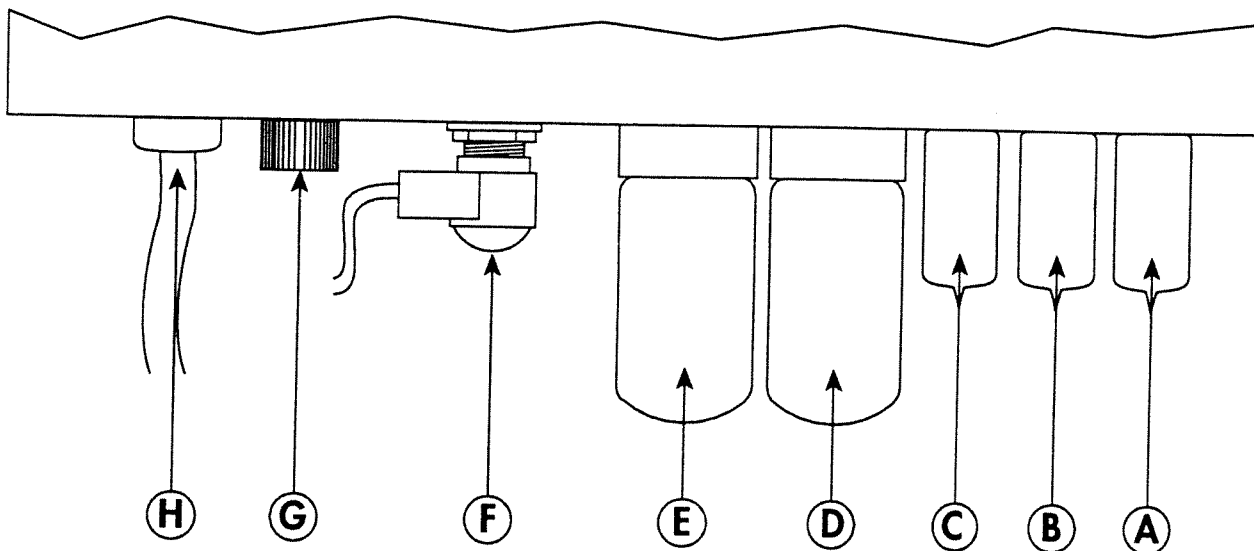

### **Blues Deluxe bottom panel functions**

**A-E.** The Blues Deluxe tube complement consists of three Fender Special Design 12AX7As (part number 013341) and two Fender Special Design 5881s (part number 039214) and provide optimum performance in this amplifier. For best results, replace with Fender original equipment 12AX7A and 5881 tubes only. Tube location is printed on the tube label located inside the cabinet.

**F. Main Speaker**-Plug-in connection for speakers.

**G. Fuse**-The fuse is in the AC supply of the amplifier and will help to protect the amplifier and the operator in the event of an electrical fault. If a fuse blows, it should only be replaced with a fuse in accordance with the listing at the fuse holder. If an amplifier repeatedly blows fuses, it should be checked out by a qualified technician. **UNDER NO CIRCUMSTANCES** should a fuse of a different type, higher current rating, or a fuse bypass be used, as this could damage the equipment and present a serious safety hazard.

**H. Line Cord**-This amplifier is equipped with a grounding type supply cord to reduce the possibility of shock hazard caused by leakage current. Be sure to connect it to a grounded AC receptacle. **DO NOT ALTER THE AC PLUG.**

**NOTE:** The tubes are not accessible by the user in Scandinavian countries. Refer any servicing or changes of this nature to a qualified technician.

### **Troubleshooter's checklist**

- Is the power cord properly plugged into an electrical outlet?
- Is there power at the outlet?
- Is the speaker properly connected to the amplifier?
- Are all the control knobs turned above four?
- Is the volume control on the instrument turned up?
- Is the instrument properly connected to the amplifier?  
(Eliminate all effects and try another guitar cord.)

If, after checking all of the above, the amplifier is still not working correctly, consult your Fender Service Dealer.

## ***Blues Deluxe specifications***

Part Number:	120V Version:	21-3102
	230V Version:	21-3162
Input Impedance:	Input 1:	1M Ohms
	Input 2:	136k Ohms
Power Output:	40 Watts into 8 Ohms at 5% THD	
Preamp Out Output Impedance:	1.5k Ohms Maximum	
Power Amp In Input Impedance:	220k Ohms Minimum	
Power Amp In Sensitivity:	300mV for clipping	
Power Requirements:	120V Version: 120 Volts AC, 60Hz, 2 Amp Max 230V Version: 230 Volts AC, 50Hz, 1 A Max	
Speakers:	One 8 Ohm Fender Re-issue "Gold Label" 12-inch speaker (P/N 037617)	
Dimensions:	Height: 18 1/2" (47.0 cm) Width: 23 1/2" (59.7 cm) Depth: 10 3/4" (27.3 cm) Weight: 40 Lbs. (18.2 kg)	

**WARNING:  
NO USER SERVICEABLE PARTS INSIDE.  
REFER SERVICING TO QUALIFIED  
PERSONNEL ONLY.**

# Blues Deluxe block diagram

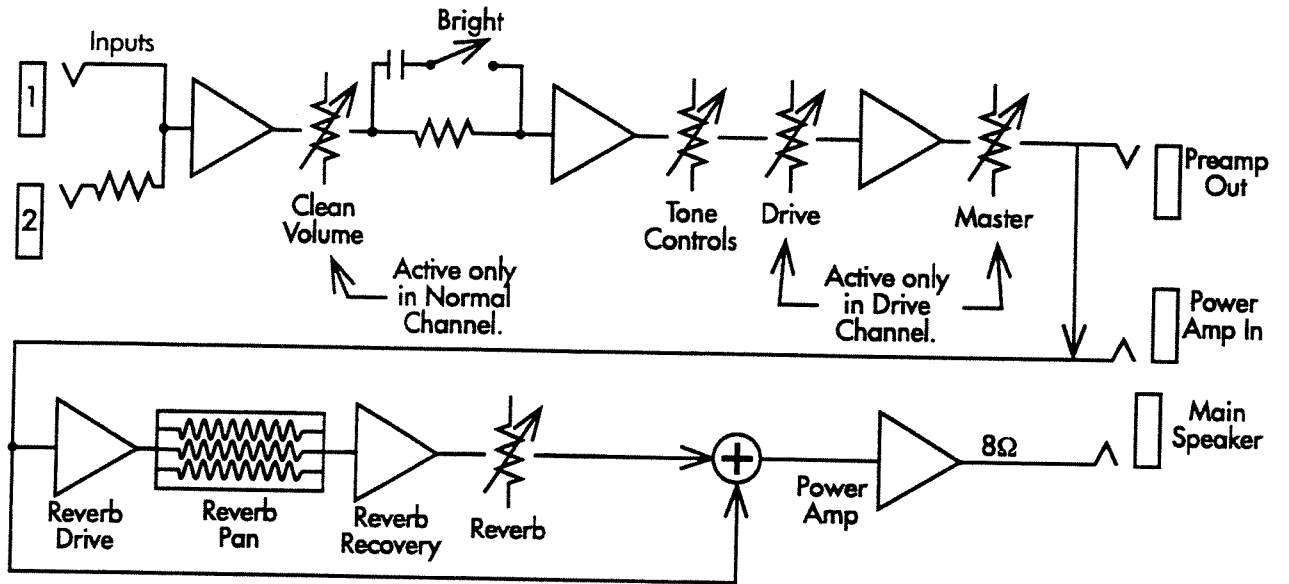

A PRODUCT OF:  
**FENDER MUSICAL INSTRUMENTS CORP.,**  
BREA, CA 92621