

# AMERICAN PERFORMER STRATOCASTER (011491XXXX)

## PARTS LAYOUT

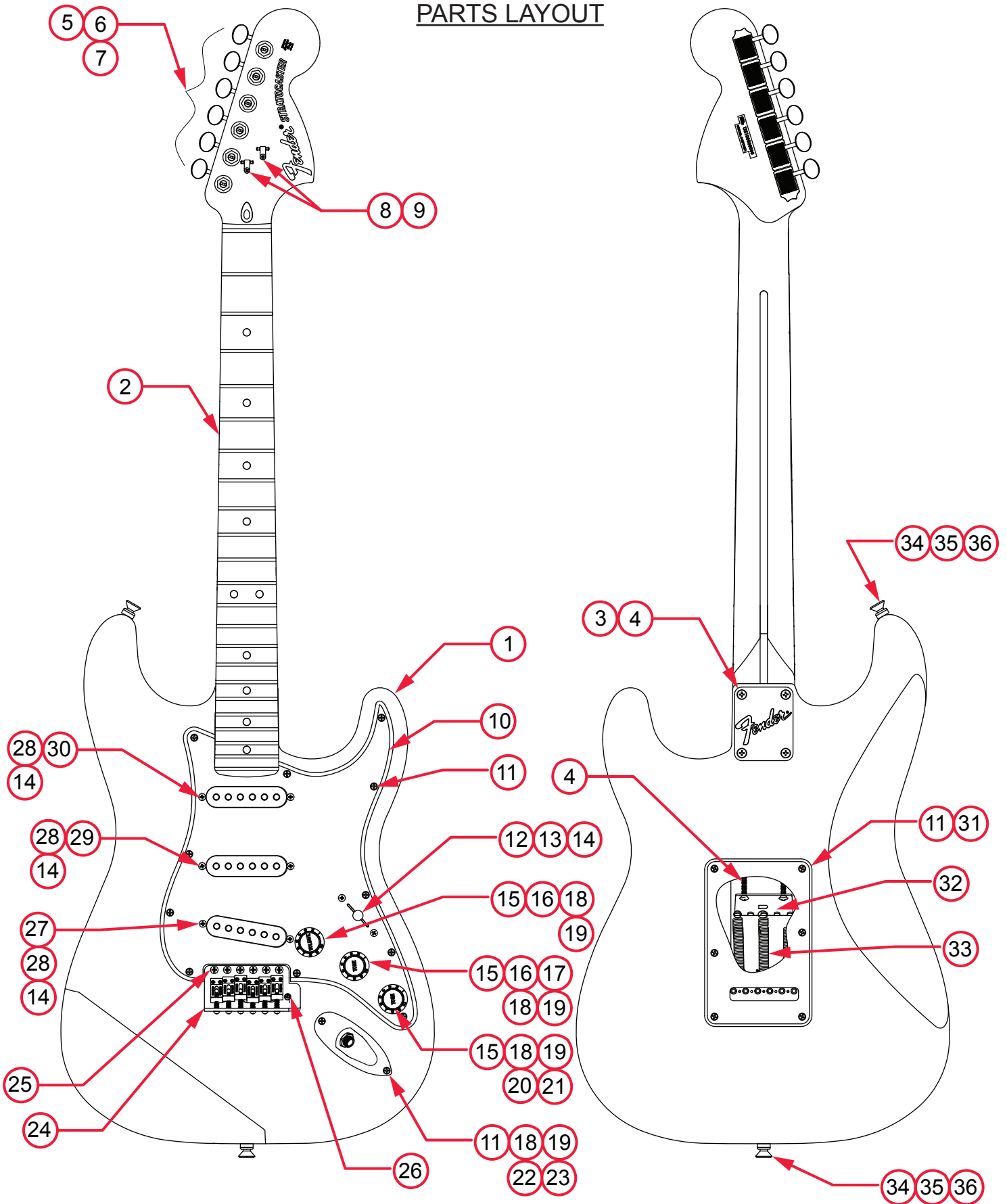

## AMERICAN PERFORMER STRATOCASTER (011491XXXX)

REF#	DESCRIPTION	PART NUMBER
1	BODY AM PERFORMER STRAT PENNY	7714102584
1	BODY AM PERFORMER STRAT LPB	7714103502
1	BODY AM PERFORMER STRAT HBST	7714102542
1	BODY AM PERFORMER STRAT AWT	7714102580
2	NECK ASSY AM PERFORMER STRAT MPL	7714149000
2	NECK ASSY AM PERFORMER STRAT RW	7713148000
3	NECK PLATE STD SERIES LOGO NO TILT	0048691000
4	SCREW SMA 8 X 1-3/4 OHP NI	0015636049
5	TUNING KEYS MODERN VINTAGE SET	7713088000
6	WASHER KEY SET	0053106049
7	BUSHING KEY SET	0058820049
8	STRING GUIDE TREE AM STD SET W/HDWR	0994911000
9	SCREW SMAB 3 X 3/8 RHP STL NI	0011357049
10	PICKGUARD STRAT B/W/B	0991359000
10	PICKGUARD STRAT MG/B/MG	0040837000
11	SCREW SMAB 4 X 1/2 OHP NI	0015578049
12	KNOB P/U SWITCH VINT AGED WHT	0994938000
13	SWITCH 5-WAY LEVER	0991367000
14	SCREW TF 6-32 X 3/4 RHP STL NI	0048631049
15	KNOBS STRAT AGED WHITE SET VOL (1) TONE (2)	0991369000
16	CONTROL 250K 10% TPR SPLIT	0990830000
17	CAPACITOR MPF RDL .022MF 250V 10%	0024832049
18	NUT HEX 3/8-32 X 3/32 TK NI	0016352049
19	WASHER LOCK INTL 3/8 X .687	0016436049
20	POT SWITCH SPLIT SHAFT PUSH-PULL 250K	0992257000
21	PCB ASSY GREASE BUCKET TONE CIRCUIT	7713546000
22	FERRULE JACK CHROME	0991940000
23	JACK PHONE 1/4 OUTPUT	0047329049
24	BRIDGE ASSY VINTAGE NARROW CHR	0072290000
25	SCREWS WOOD RD PH 6 X 1-1/8 NI	0016170049
26	SPRINGS .150 OD 1/2" LONG .039"	0994931000
27	PICKUP AM PERFORMER STRAT BRIDGE AGED WHITE	7713378000
28	TUBING LATEX CUT .300 X 1/8ID X 1/4OD	0994916000
29	PICKUP AM PERFORMER STRAT MID AGED WHITE	7713375000
30	PICKUP AM PERFORMER STRAT NECK AGED WHITE	7713372000

\*= NOT PICTURED IN DIAGRAM



# AMERICAN PERFORMER STRATOCASTER (011491XXXX)

## PARTS LIST

REF#	DESCRIPTION	PART NUMBER
31	COVER BACK STRAT STD W/SOLT MG/B/MG	0054029049
31	COVER BACK STRAT STD W/SOLT B/W/B	0038492000
32	SPRING TREMOLO CLAW NICKEL	0050918000
33	SPRING TREMOLO TENSION VINTAGE	0031643049
34	BUTTON STRAP NICKEL PLATED SET W/HDWR	0994915000
35	SCREW WOOD 6 X 1 OHP NI	0016188049
36	WASHER FELT BLACK	0994929000
36	WASHER FELT WHITE	0994930000
*	WRENCH .050 HEX KEY (SADDLE HEIGHT ADJUSTMENT)	0018531049
*	WRENCH 1/8 HEX KEY (TRUSS ROD ADJUSTMENT)	0023811049
*	DELUXE GIG BAG ELECTRIC GUITAR	0991512000

\*= NOT PICTURED IN DIAGRAM







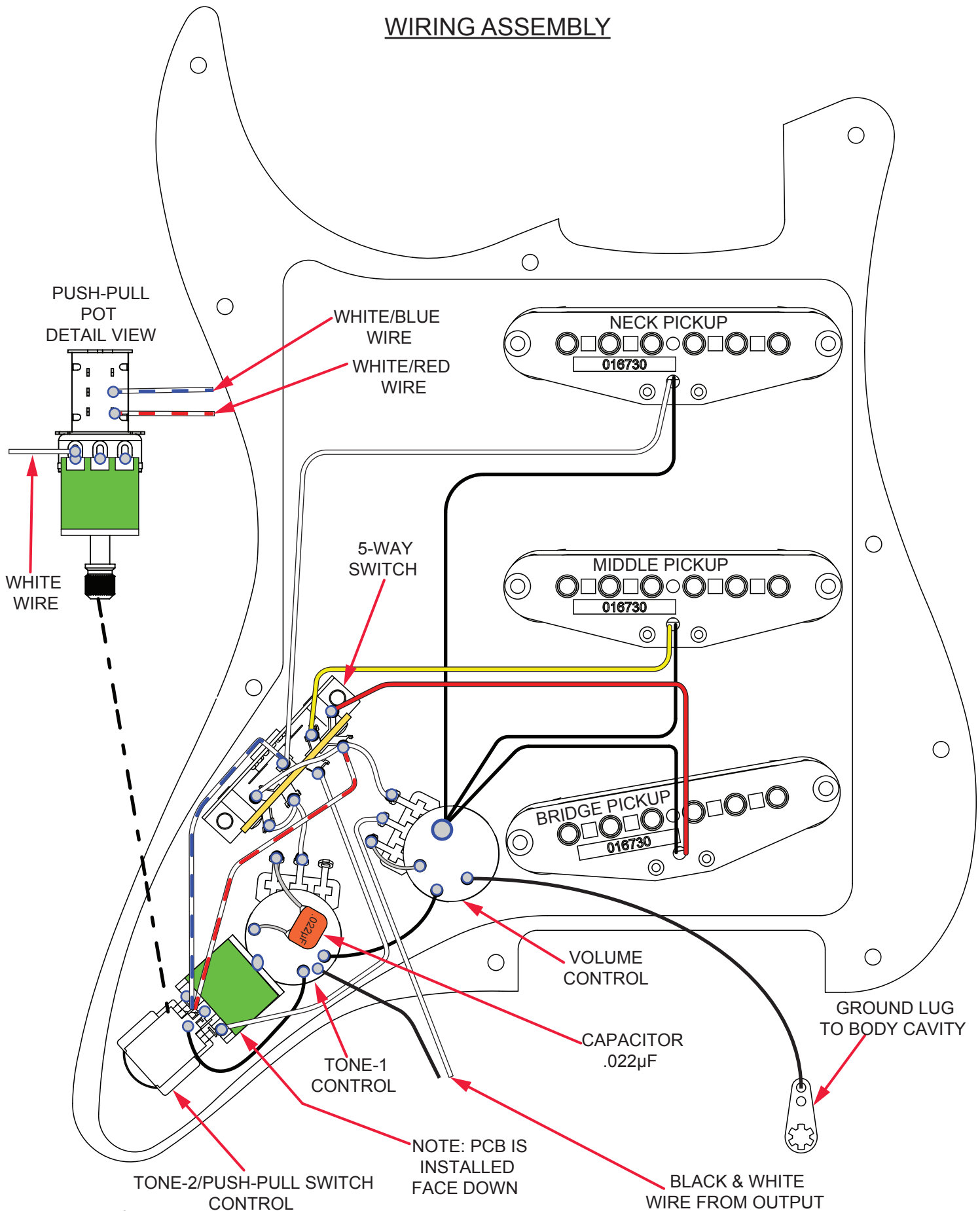















# AMERICAN PERFORMER STRATOCASTER (011491XXXX)





















## WIRING ASSEMBLY



# AMERICAN PERFORMER STRATOCASTER (011491XXXX)

## SWITCH AND CONTROL FUNCTION

TONE CONTROL	T1 ONLY	T1 ONLY	T1 ONLY	T1& T2	T2 ONLY	 PUSH-PULL SWITCH OFF  COMBINED PICKUPS ARE IN PARALLEL
5-WAY SWITCH POSITION						
NECK PICKUP						
MIDDLE PICKUP						
BRIDGE PICKUP						

TONE CONTROL	T1 ONLY	T1 ONLY	T1 ONLY	T1& T2	T2 ONLY	 PUSH-PULL SWITCH ON  COMBINED PICKUPS ARE IN PARALLEL
5-WAY SWITCH POSITION						
NECK PICKUP						
MIDDLE PICKUP						
BRIDGE PICKUP						

PICKUP IS ON  PICKUP IS OFF 

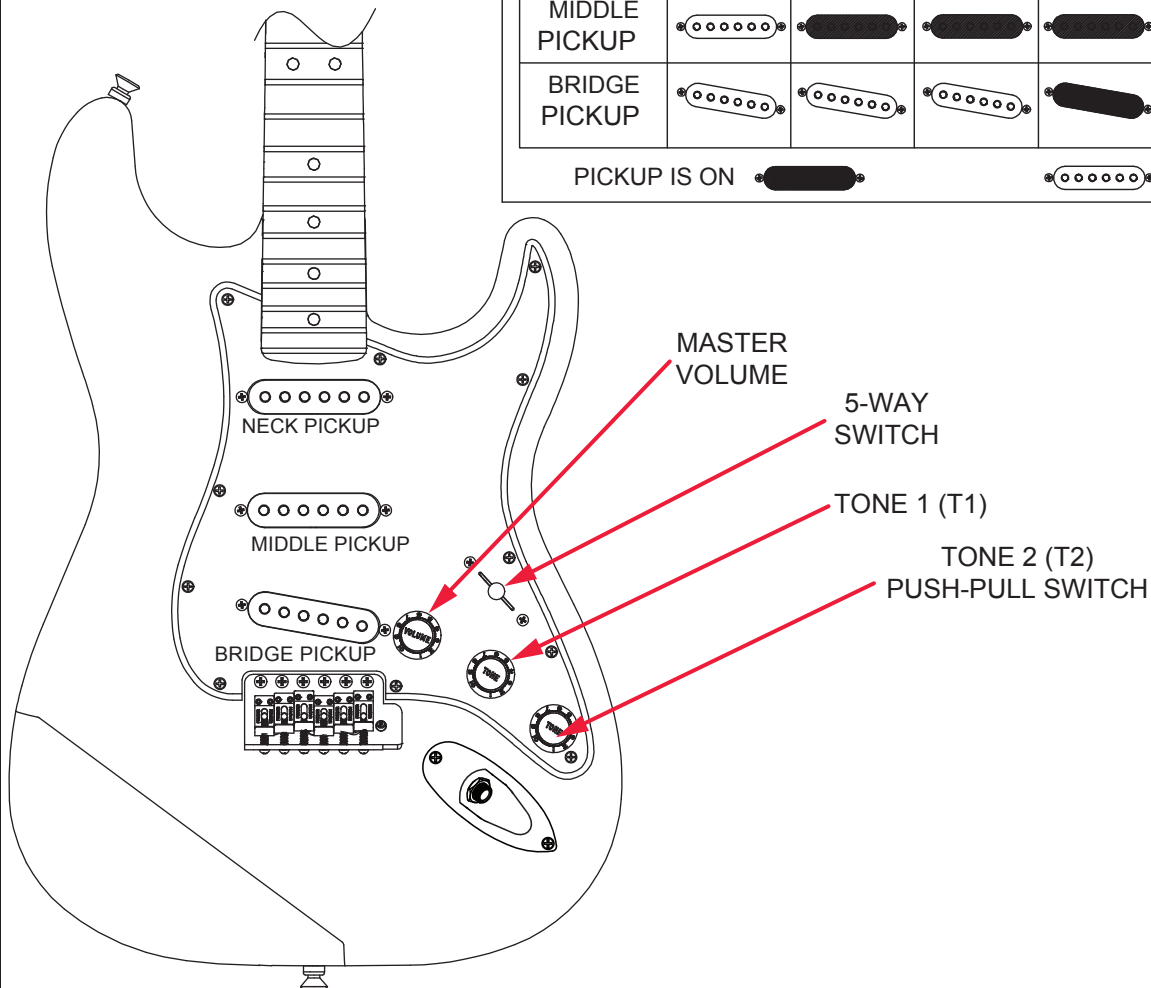

# AMERICAN PERFORMER STRATOCASTER (011491XXXX)

## ADDITIONAL SPECIFICATION DETAIL

**FRET SIZE: JUMBO**  
(FRET DIMENSIONS ARE BEFORE INSTALLATION)

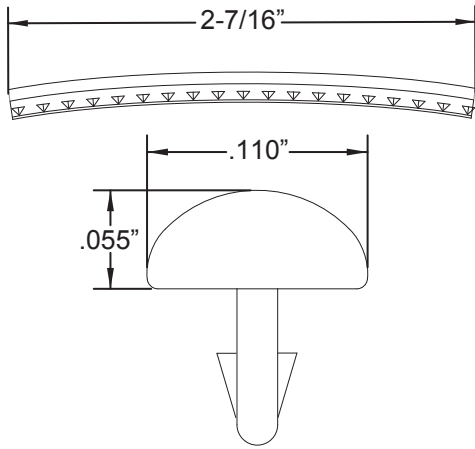

PLEASE NOTE: AS EACH NECK IS SANDED & FINISHED BY HAND, THICKNESS DIMENSIONS MAY VARY SLIGHTLY FROM THOSE SHOWN.

**NECK PROFILE: MODERN "C"**

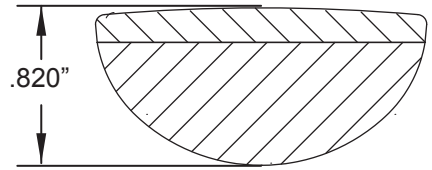

1ST FRET PROFILE

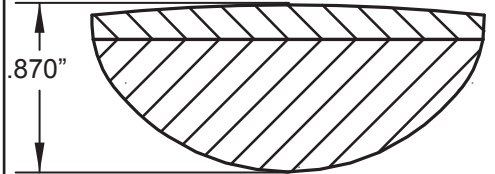

12TH FRET PROFILE

**STAGGERED TUNING MACHINE SET P/N 7713088000**  
**OUTER SHAFT DIAMETER .394"**

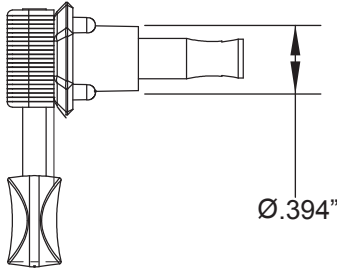

**TUNING MACHINE THRU-HOLE**  
**INNER DIAMETER .404"**

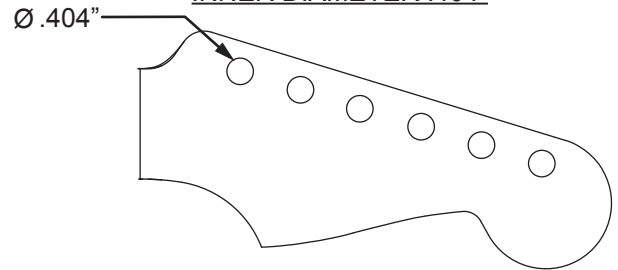

**SADDLE HEIGHT ADJUSTMENT WRENCH:**  
**.050" HEX KEY P/N 0018531049**

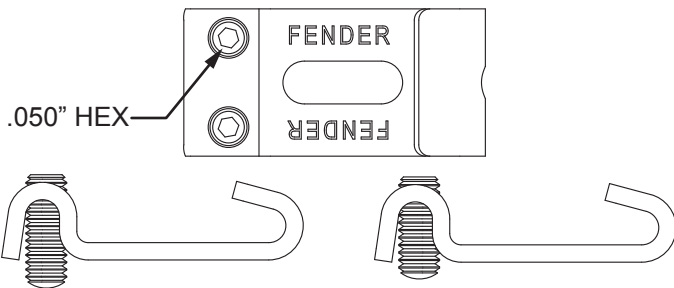

**TRUSS ROD NUT P/N 0994943000**  
**TRUSS ROD ADJUSTMENT WRENCH:**  
**1/8" HEX KEY P/N 0023811049**

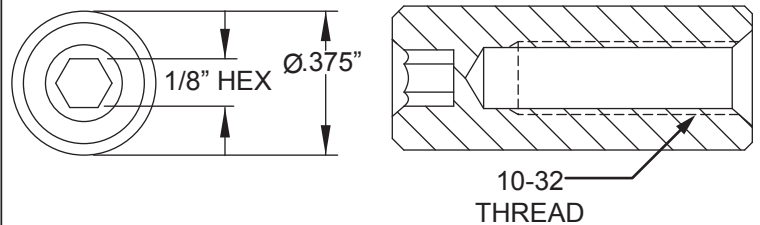

**SADDLE HEIGHT ADJUSTMENT SCREWS:**

TALL: P/N 0075384000      SHORT: P/N 0075536000

**LOGO: AMERICAN PERFORMER STRAT**  
**APPLIED UNDER THE FINISH**



### PICKUP SPECIFICATIONS

POSITION	MAGNETS	DC RESISTANCE	POLARITY
NECK	ALNICO 4 BEVELED	7.5 - 8.1KΩ	NORTH
MIDDLE	ALNICO 4 BEVELED	8.2 - 8.8KΩ	SOUTH
BRIDGE	ALNICO 2 BEVELED	8.6 - 9.2KΩ	NORTH