

AMERICAN PRO STRATOCASTER® (011301XXXX)

PARTS LAYOUT

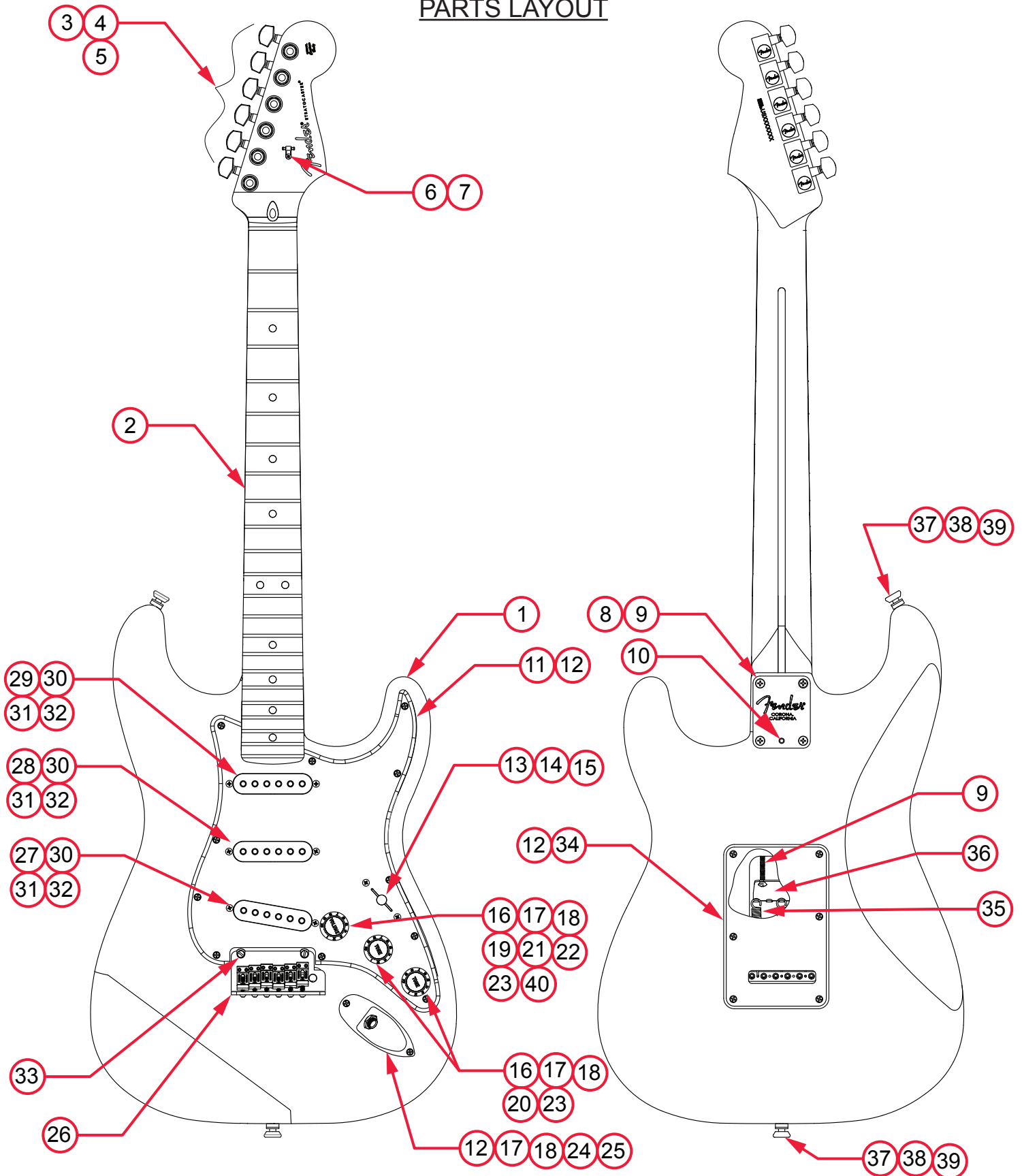

AMERICAN PRO STRATOCASTER® (011301XXXX)

PARTS LIST

REF#	DESCRIPTION	PART NUMBER
1	BODY AM PRO STRAT 3TS	0054014500
1	BODY AM PRO STRAT OWT	0056229505
1	BODY AM PRO STRAT BLK	0056229506
1	BODY AM PRO STRAT SSB	0054015547
1	BODY AM PRO STRAT SNG	0056229548
1	BODY AM PRO STRAT ATO	0056229576
1	BODY AM PRO STRAT NAT	0054015000
1	BODY AM PRO STRAT CAR	0056229509
2	NECK ASSY AM PRO STRAT RW	7709880000
2	NECK ASSY AM PRO STRAT MPL	7709881000
3	KEYS 2 PIN MOUNT SET W/HARDWARE	0990820100
4	KEY WASHER	0053106049
5	KEY BUSHING	0058820049
6	STRING TREE W/HARDWARE	0994911000
7	SCREW SMAB 3 X 3/8 RHP STL NI	0011357049
8	NECK PLATE CORONA CA TILT W/HARDWARE	0991445100
9	SCREW SMA 8 X 1-3/4 OHP NI	0015636049
10	SET SCREW 1/4-20 X 3/8 OP NI HEX	0031571000
11	PICKGUARD STRAT AM STD P/B/P	0056198000
11	PICKGUARD STRAT AM STD B/W/B	0991359000
11	PICKGUARD STRAT AM STD MG/BLK/MG	0040837000
12	SCREW SMAB 4 X 1/2 OHP NI	0015578049
13	5-WAY SELECTOR SWITCH	0991367000
14	SCREW MA 6-32 X 5/8 RH NI	0994925000
15	KNOB PICKUP SWITCH VINT AGED WHITE	0994938000
16	CONTROL 250K 10% TPR SPLIT	0990830000
17	NUT HEX 3/8-32 X 3/32	0016352049
18	WASHER LCK INTNL 3/8 X 500 X .02 NI	0022384049
19	CAPACITOR CD 1200pF 1000V 10%	0065862000
20	CAPACITOR MPF RDL .022MF 250 V 10%	0024832049
21	RES CF 1/4W 20K 5%	0029006001
22	RES CF 1/4W 150K 5%	0024999001
23	KNOBS STRAT 1-VOL 2-TONE AGED WHITE	0991369000
24	FERRULE JACK CHROME	0991940000
25	JACK PHONE OPEN CIRCUIT 11	0021956049
26	BRIDGE ASSY AM PRO STRAT	7709950000

*= NOT PICTURED IN DIAGRAM



AMERICAN PRO STRATOCASTER® (011301XXXX)

REF#	DESCRIPTION	PART NUMBER
26B	BLOCK TREMOLO AM DLX STRAT RH SILVER MET	0077090000
26C	BRIDGE SECTION ASSY NI AS STRAT SHORT	0075123101
26D	BRIDGE SECTION ASSY NI AS STRAT TALL	0075123102
26E	SPRING BRIDGE #1932	0019281049
26F	SCREW M 4-40 X 5/8 RHP NI	0015693049
26G	SCREW M 8-32 X 3/8 FHP NI	0019656049
26H	SPRING CLIP ULTRA	0036531000
26I	BUSHING NYL NAT .31 OD X .191 ID X .87 L	7710005000
26J	SET SCREW 10-32 X 3/16 HEX SKT FP BLX	0036615049
27	PICKUP AM PRO SHAW BRIDGE AGED WHITE	7709878000
28	PICKUP AM PRO SHAW MIDDLE AGED WHITE	7709890000
29	PICKUP AM PRO SHAW NECK AGED WHITE	7709892000
30	PICKUP COVERS STRAT VINTAGE AGED WHITE	0053824049
31	TUBING LATEX CUT .300 X 1/8 ID X 1/4 OD	0994916000
32	SCREW TF 6-32 X 3/4 RHP STL NI	0099346000
33	BRIDGE PIVOT POST ASSY	0093273000
34	BACK COVER STRAT STD W/SLOT RH MG/BLK/MG	0054029000
34	BACK COVER STRAT STD W/SLOT RH P/B/P	0056212000
34	BACK COVER STRAT STD W/SLOT RH B/W/B	0038492000
35	SPRING TREMOLO TENSION BLX	0018671049
36	TREM CLAW SPRING TENSION ZINC	0010272100
37	STRAP BUTTONS CHROME W/HARDWARE	0063267049
38	FELT WASHERS WHITE	0994930000
38	FELT WASHER BLACK	0994929000
39	WOOD SCREW 6 X 1 OHP NI	0016188049
40	PCB ASSY TREBLE BLEED AM PRO STRAT/TELE	7711092000
*	CASE AM ELITE GUITAR	7710537000
*	TRMOLO ARM AM PRO STRAT RH POLISHED SS	7709929000
*	TREMOLO ARM KNOB VINT AGED WHITE	0994933000
*	WRENCH HEX KEY 1/8 (TRUSS ROD ADJUSTMENT / TILT NECK ADJUSTMENT)	0023811049
*	WRENCH HEX KEY .050 (SADDLE HEIGHT ADJUSTMENT)	0018531049

*= NOT PICTURED IN DIAGRAM



AMERICAN PRO STRATOCASTER® (011301XXXX)

WIRING ASSEMBLY

RESISTOR & CAPACITOR TREBLE BLEED CIRCUIT

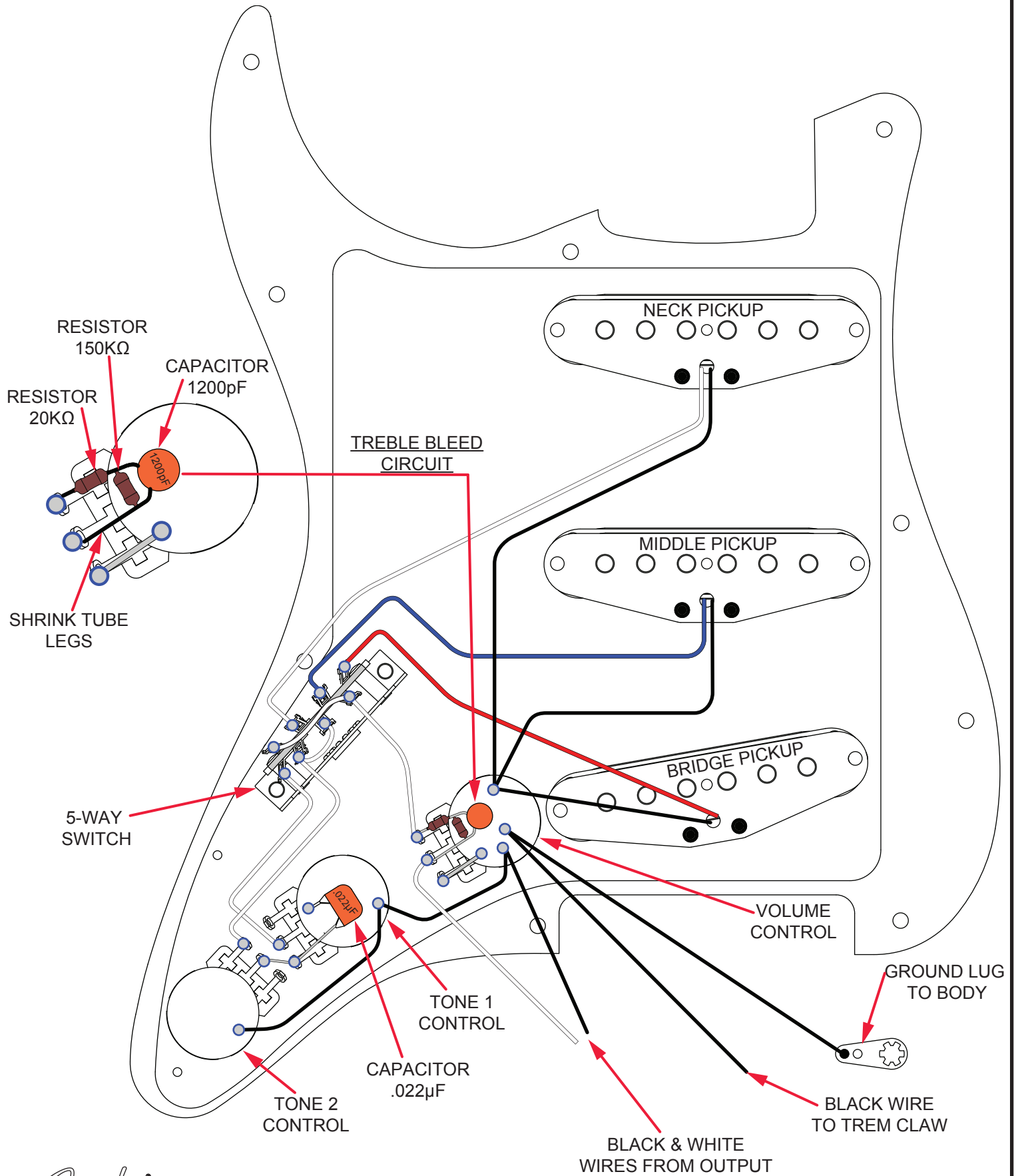

AMERICAN PRO STRATOCASTER® (011301XXXX)

WIRING ASSEMBLY PCB TREBLE BLEED CIRCUIT

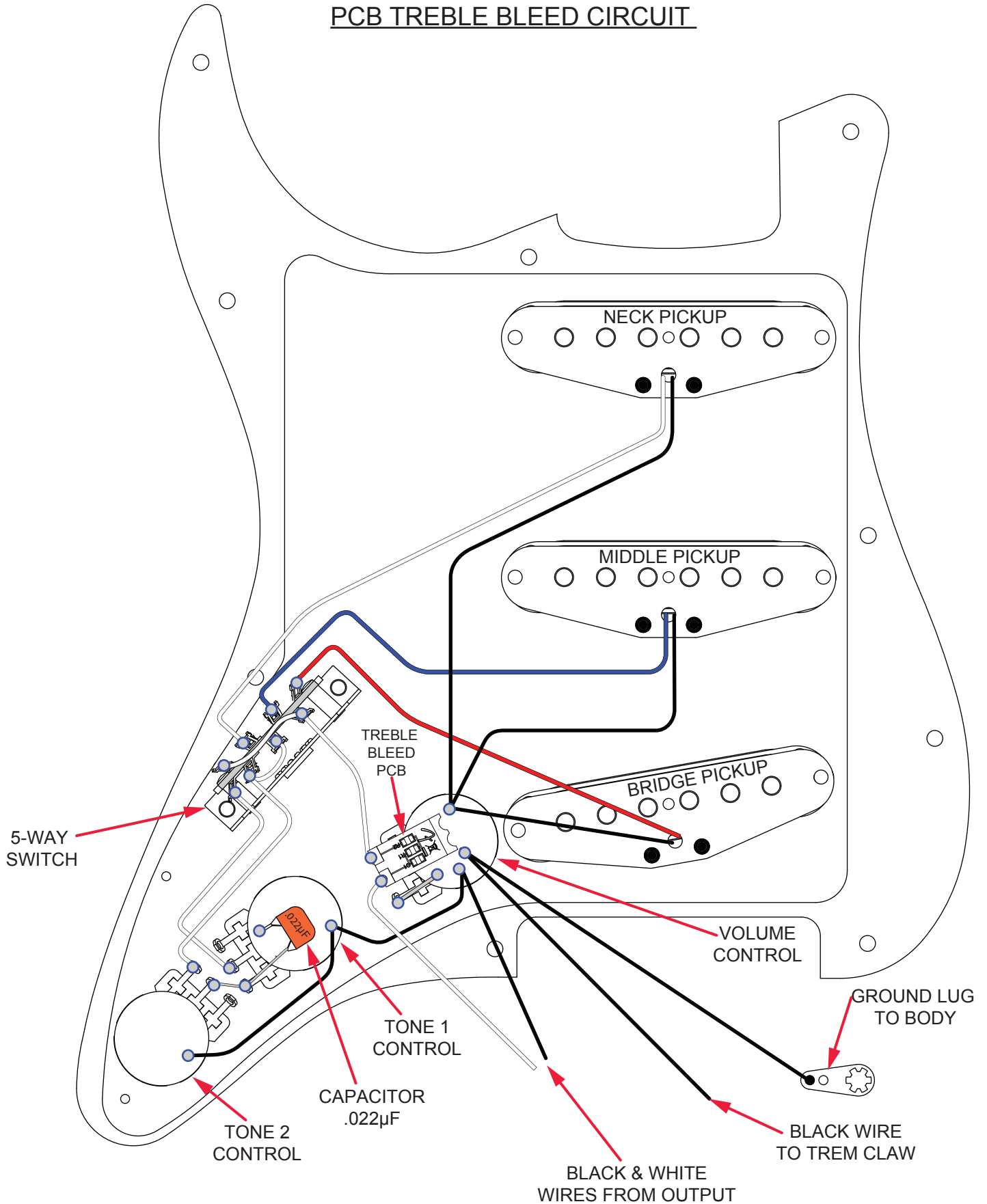

AMERICAN PRO STRATOCASTER® (011301XXXX)

SWITCH AND CONTROL FUNCTION

5 WAY SWITCH POSITION					
					SWITCH POSITION
T1	T1 & T2	T2	T2	T2	← CONTROL
					← NECK PICKUP
					← MIDDLE PICKUP
					← BRIDGE PICKUP
PICKUP IS ON	INDICATES POSITION OF 5 WAY SWITCH				
PICKUP IS OFF					

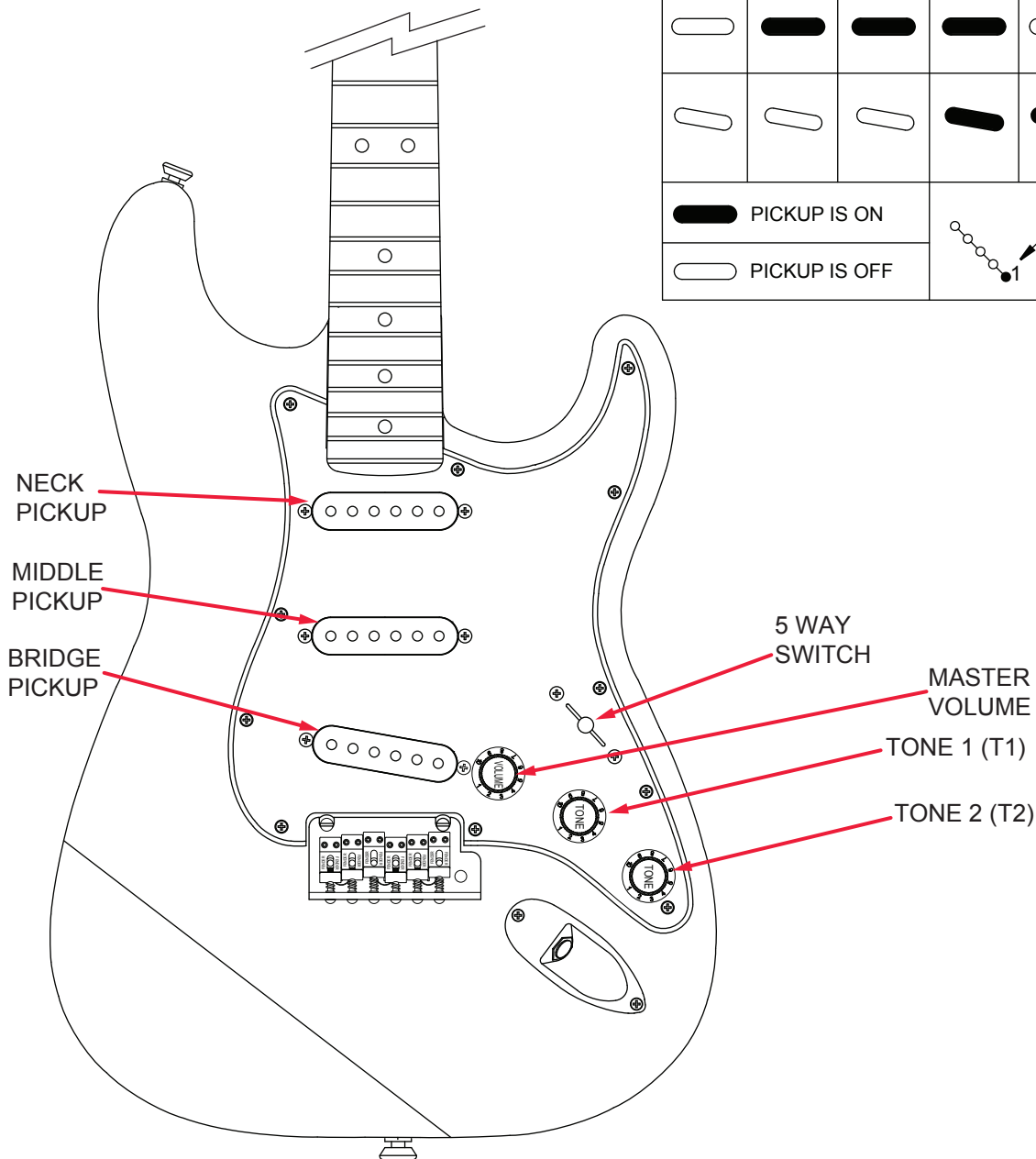

AMERICAN PRO STRATOCASTER® (011301XXXX)

ADDITIONAL SPECIFICATION DETAIL

FRET SIZE: JUMBO NARROW
(FRET DIMENSIONS ARE BEFORE INSTALLATION)

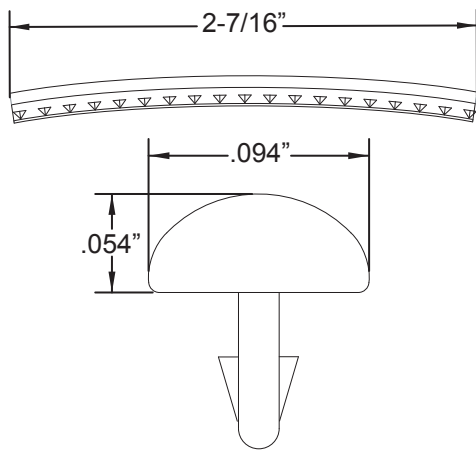

PLEASE NOTE: AS EACH NECK IS SANDED & FINISHED BY HAND, THICKNESS DIMENSIONS MAY VARY SLIGHTLY FROM THOSE SHOWN.

NECK PROFILE: MODERN DEEP "C"

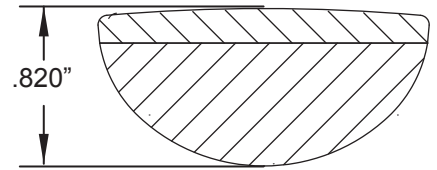

1ST FRET PROFILE

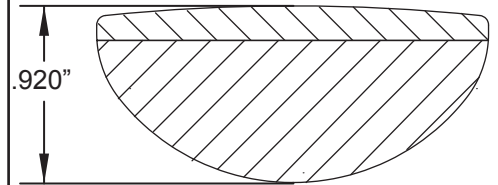

12TH FRET PROFILE

STAGGERED TUNING MACHINE SET W/HDWR P/N 0990820100

OUTER SHAFT DIAMETER .394"

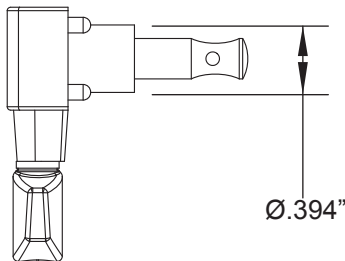

TUNING MACHINE THRU-HOLE

INNER DIAMETER .404"

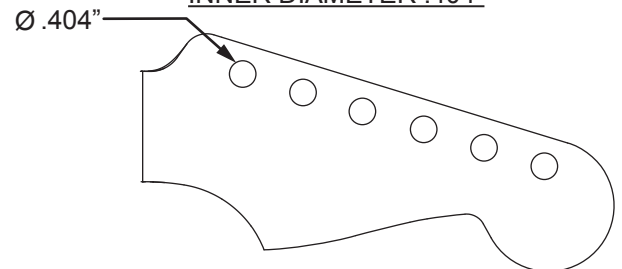

SADDLE HEIGHT ADJUSTMENT WRENCH:

.050" HEX KEY P/N 0018531049

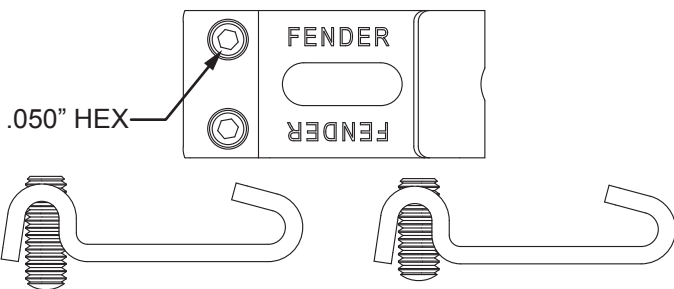

SADDLE HEIGHT ADJUSTMENT SCREWS:

TALL: P/N 0075384000

SHORT: P/N 0075536000

TRUSS ROD NUT P/N 0994943000

TRUSS ROD ADJUSTMENT WRENCH:

1/8" HEX KEY P/N 0023811049

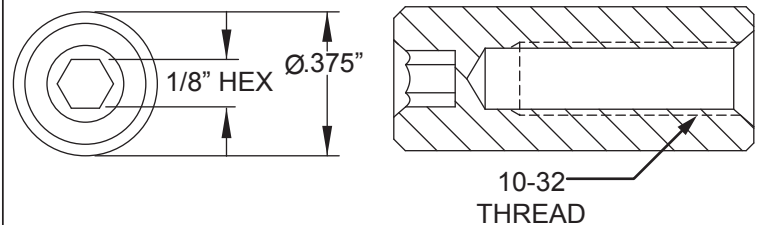

LOGO: AMERICAN PRO STRAT
APPLIED UNDER THE FINISH



PICKUP SPECIFICATIONS

POSITION	MAGNETS	DC RESISTANCE	POLARITY
NECK	ALNICO 2 & 3 BEVELED	6.1 - 6.7KΩ	SOUTH
MIDDLE	ALNICO 5 & 2 BEVELED	6.4 - 7.0KΩ	NORTH
BRIDGE	ALNICO 5 BEVELED	6.4 - 7.0KΩ	SOUTH