

AMERICAN PRO STRATOCASTER® LH (0113030000)

PARTS LAYOUT

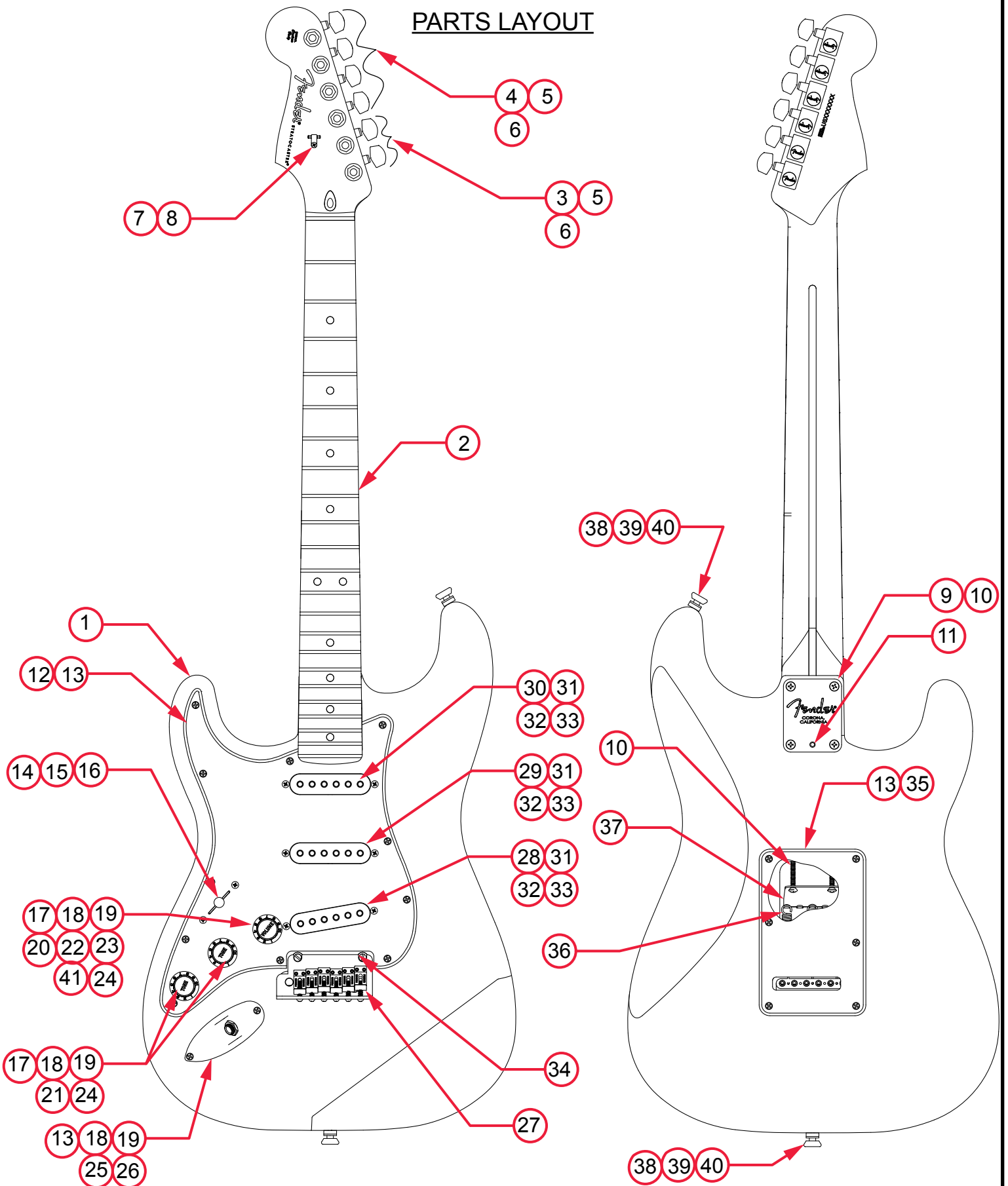

AMERICAN PRO STRATOCASTER® LH (0113030000)

PARTS LIST

REF#	DESCRIPTION	PART NUMBER
1	BODY AM PRO STRAT LH 3TS	0048702500
1	BODY AM PRO STRAT LH OWT	0056239505
1	BODY AM PRO STRAT LH BLK	0056239506
2	NECK ASSY AM PRO STRAT LH RW	7709884000
2	NECK ASSY AM PRO STRAT LH MPL	7709885000
3	KEY 2-PIN MTG TALL LH	0073119000
4	KEY 2-PIN MTG SHORT LH	0073120000
5	KEY WASHER	0053106049
6	KEY BUSHING	0058820049
7	STRING TREE W/HARDWARE	0994911000
8	SCREW SMAB 3 X 3/8 RHP STL NI	0011357049
9	NECK PLATE CORONA CA TILT W/HARDWARE	0991445100
10	SCREW SMA 8 X 1-3/4 OHP NI	0015636049
11	SET SCREW 1/4-20 X 3/8 OP NI HEX	0031571000
12	PICKGUARD STRAT AM STD LH P/B/P	0056199000
12	PICKGUARD STRAT AM STD LH MG/BLK/MG	0055320000
13	SCREW SMAB 4 X 1/2 OHP NI	0015578049
14	5-WAY SELECTOR SWITCH	0991367000
15	SCREW MA 6-32 X 5/8 RH NI	0994925000
16	KNOB PICKUP SWITCH VINT AGED WHITE	0994938000
17	CONTROL 250K 10% R-AUDIO SPLIT SHAFT	0063892000
18	NUT HEX 3/8-32 X 3/32	0016352049
19	WASHER LCK INTNL 3/8 X 500 X .02 NI	0022384049
20	CAPACITOR CD 1200pF 1000V 10%	0065862000
21	CAPACITOR MPF RDL .022MF 250 V 10%	0024832049
22	RES CF 1/4W 20K 5%	0029006001
23	RES CF 1/4W 150K 5%	0024999001
24	KNOBS STRAT 1-VOL 2-TONE AGED WHITE	0991369000
25	FERRULE JACK CHROME	0991940000
26	JACK PHONE OPEN CIRCUIT 11	0021956049
27	BRIDGE ASSY AM PRO STRAT LH	7709951000
27A	BRIDGE PLATE TREM AM PRO STRAT LH CHROME	7709900000

*= NOT PICTURED IN DIAGRAM



AMERICAN PRO STRATOCASTER® LH (0113030000)

REF#	DESCRIPTION	PART NUMBER
27B	BLOCK TREMOLO AM DLX STRAT LH SILVER MET	0077091000
27C	BRIDGE SECTION ASSY NI AS STRAT SHORT	0075123101
27D	BRIDGE SECTION ASSY NI AS STRAT TALL	0075123102
27E	SPRING BRIDGE #1932	0019281049
27F	SCREW M 4-40 X 5/8 RHP NI	0015693049
27G	SCREW M 8-32 X 3/8 FHP NI	0019656049
27H	SPRING CLIP ULTRA	0036531000
27I	BUSHING NYL NAT .31 OD X .191 ID X .87 L	7710005000
27J	SET SCREW 10-32 X 3/16 HEX SKT FP BLX	0036615049
28	PICKUP AM PRO SHAW BRIDGE LH AGED WHITE	7709879000
29	PICKUP AM PRO SHAW MIDDLE LH AGED WHITE	7709891000
30	PICKUP AM PRO SHAW NECK LH AGED WHITE	7709893000
31	PICKUP COVERS STRAT VINTAGE AGED WHITE	0053824049
32	TUBING LATEX CUT .300 X 1/8 ID X 1/4 OD	0994916000
33	SCREW TF 6-32 X 3/4 RHP STL NI	0099346000
34	BRIDGE PIVOT POST ASSY	0093273000
35	BACK COVER STRAT STD W/SLOT LH MG/BLK/MG	0055322000
35	BACK COVER STRAT STD W/SLOT LH P/B/P	0056214000
36	SPRING TREMOLO TENSION BLX	0018671049
37	TREM CLAW SPRING TENSION ZINC	0010272100
38	STRAP BUTTONS CHROME W/HARDWARE	0063267049
39	FELT WASHERS WHITE	0994930000
39	FELT WASHER BLACK	0994929000
40	WOOD SCREW 6 X 1 OHP NI	0016188049
41	PCB ASSY TREBLE BLEED AM PRO STRAT/TELE	7711092000
*	CASE AM ELITE GUITAR	7710537000
*	TRMOLO ARM AM PRO STRAT RH POLISHED SS	7709929000
*	TREMOLO ARM KNOB VINT AGED WHITE	0994933000
*	WRENCH HEX KEY 1/8 (TRUSS ROD ADJUSTMENT / TILT NECK ADJUSTMENT	0023811049
*	WRENCH HEX KEY .050 (SADDLE HEIGHT ADJUSTMENT)	0018531049

*= NOT PICTURED IN DIAGRAM



AMERICAN PRO STRATOCASTER® LH (0113030000)

WIRING ASSEMBLY RESISTOR & CAPACITOR TREBLE BLEED CIRCUIT

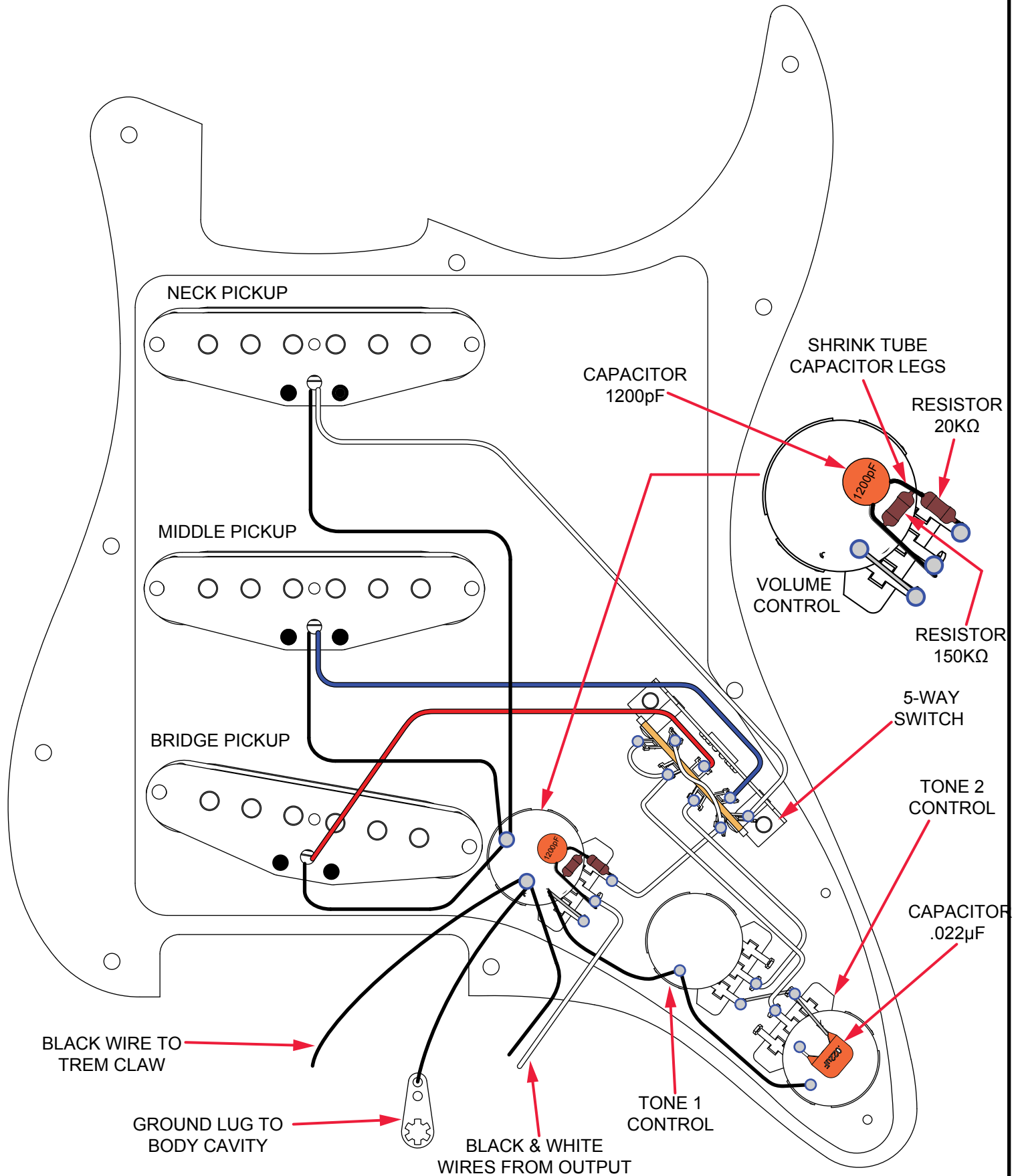

AMERICAN PRO STRATOCASTER® LH (0113030000)

WIRING ASSEMBLY PCB TREBLE BLEED CIRCUIT

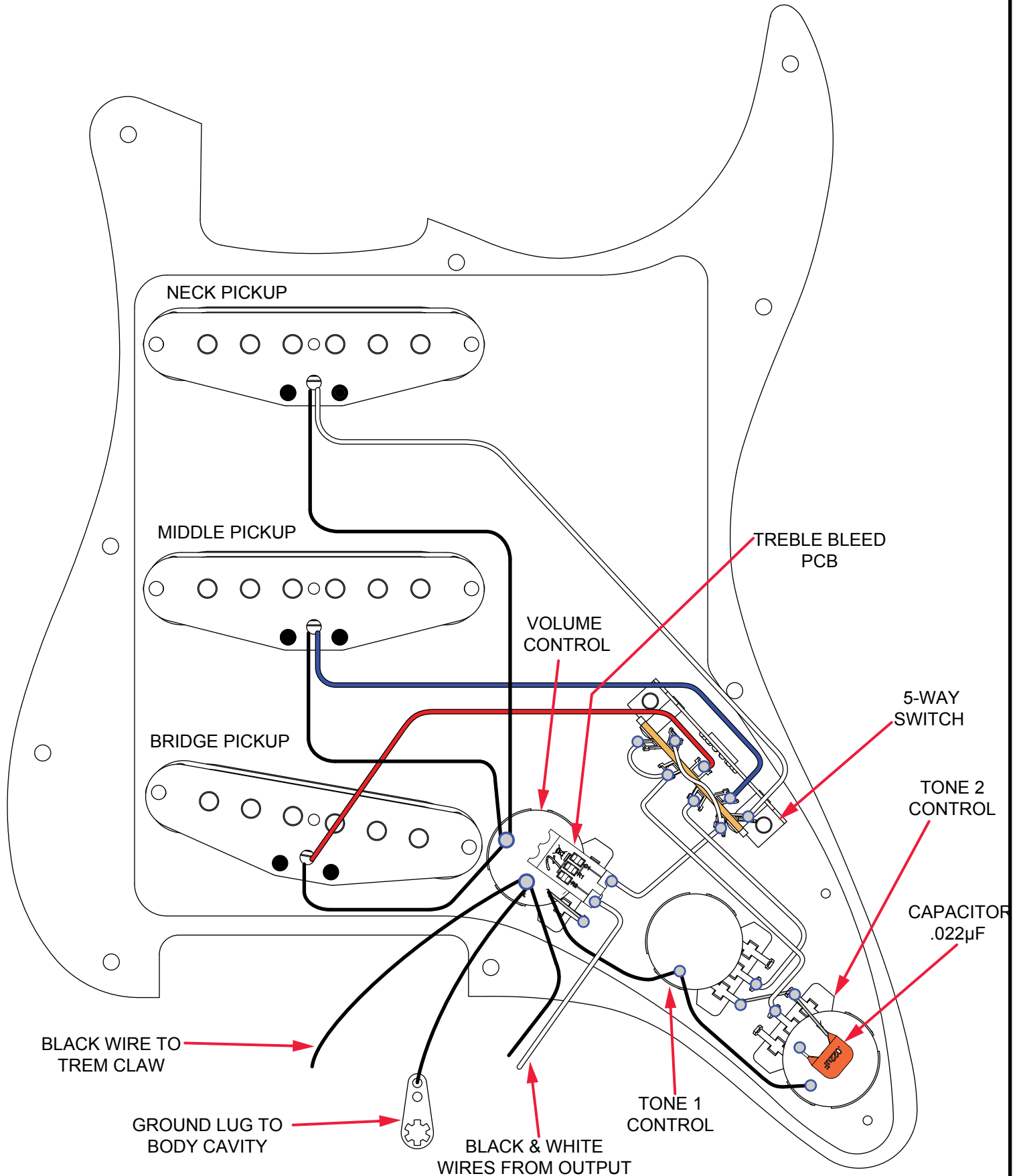

AMERICAN PRO STRATOCASTER® LH (0113030000)

SWITCH AND CONTROL FUNCTION

5 WAY SWITCH POSITION					
					5-WAY SWITCH POSITION
T1	T1 & T2	T2	T2	T2	← TONE CONTROL
					← NECK PICKUP
					← MIDDLE PICKUP
					← BRIDGE PICKUP
PICKUP IS ON PICKUP IS OFF				INDICATES POSITION OF 5-WAY SWITCH	

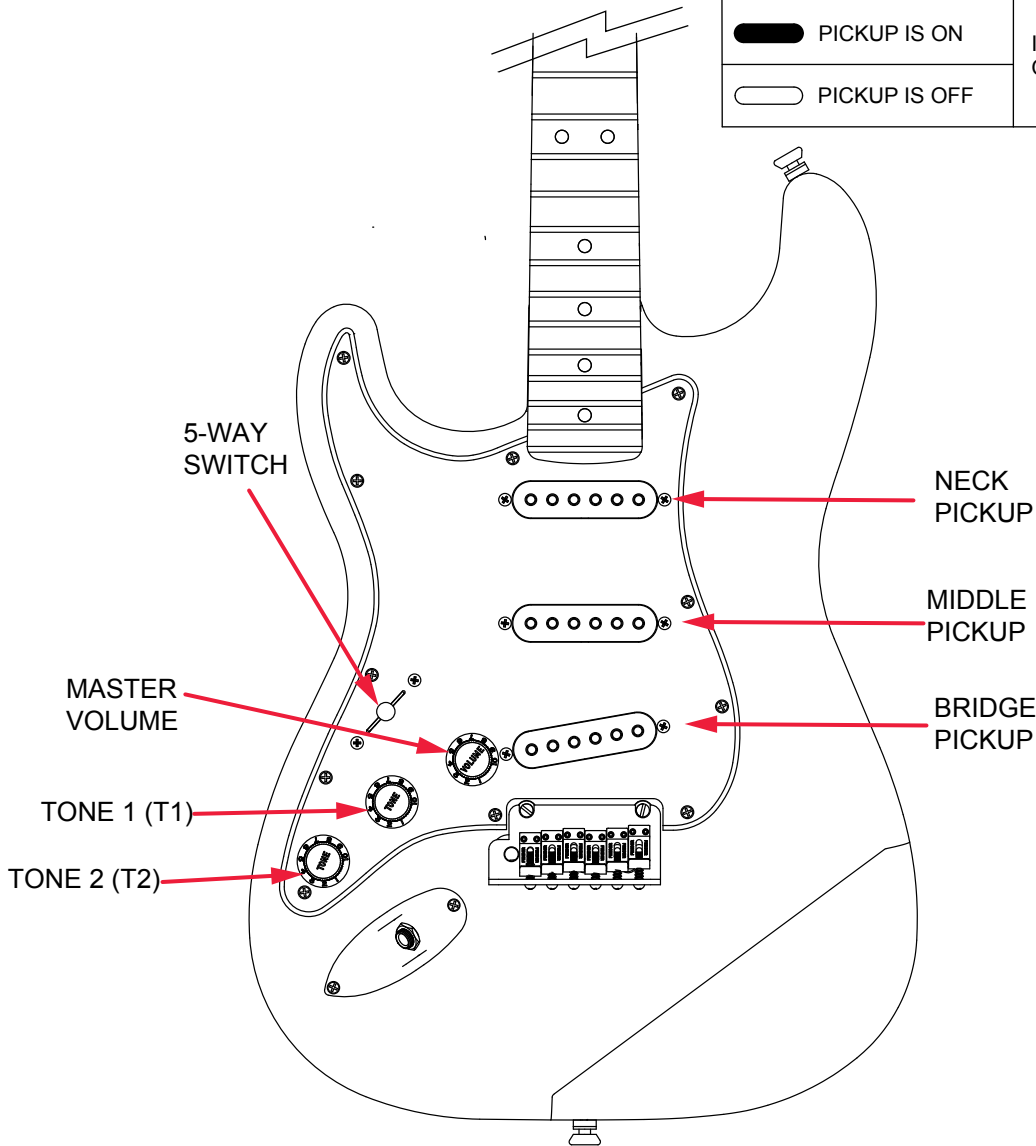

AMERICAN PRO STRATOCASTER® LH (0113030000)

ADDITIONAL SPECIFICATION DETAIL

FRET SIZE: JUMBO NARROW
(FRET DIMENSIONS ARE BEFORE INSTALLATION)

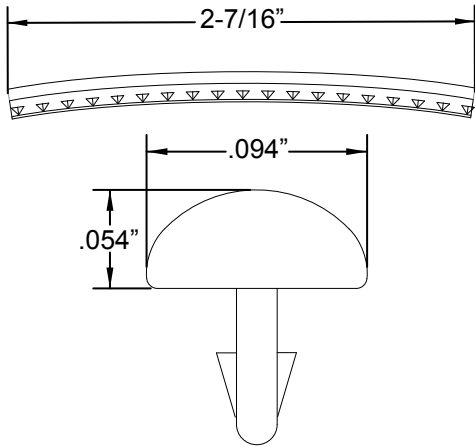

PLEASE NOTE: AS EACH NECK IS SANDED & FINISHED BY HAND, THICKNESS DIMENSIONS MAY VARY SLIGHTLY FROM THOSE SHOWN.

NECK PROFILE: MODERN DEEP "C"

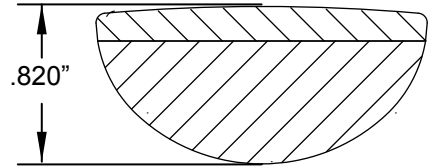

1ST FRET PROFILE

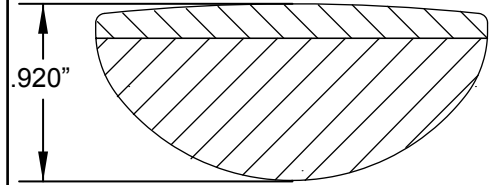

12TH FRET PROFILE

STAGGERED TUNING MACHINE SET W/HDWR P/N 0990820100

OUTER SHAFT DIAMETER .394"

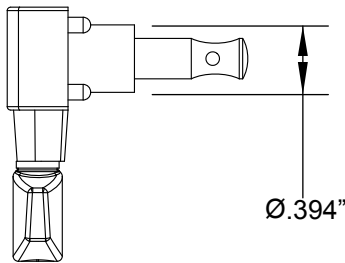

TUNING MACHINE THRU-HOLE

INNER DIAMETER .404"

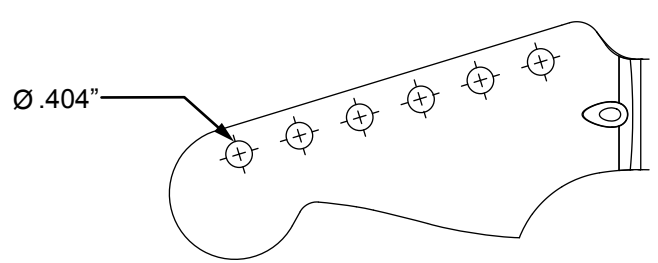

SADDLE HEIGHT ADJUSTMENT WRENCH:

.050" HEX KEY P/N 0018531049

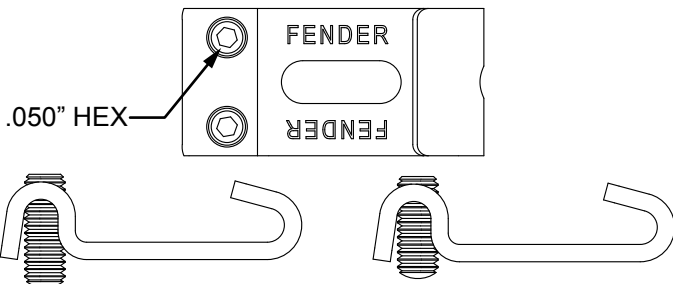

SADDLE HEIGHT ADJUSTMENT SCREWS:

TALL: P/N 0075384000 SHORT: P/N 0075536000

TRUSS ROD NUT P/N 0994943000

TRUSS ROD ADJUSTMENT WRENCH:

1/8" HEX KEY P/N 0023811049

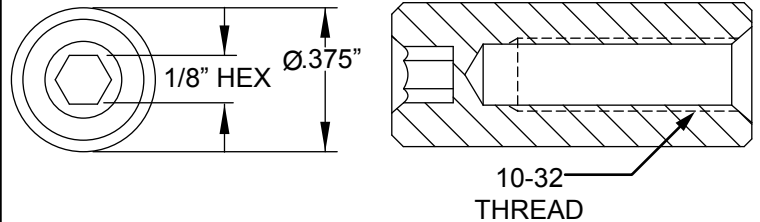

LOGO: AMERICAN PRO STRAT LH

APPLIED UNDER THE FINISH



PICKUP SPECIFICATIONS

POSITION	MAGNETS	DC RESISTANCE	POLARITY
NECK	ALNICO 2 & 3 BEVELED	6.1 - 6.7KΩ	SOUTH
MIDDLE	ALNICO 5 & 2 BEVELED	6.4 - 7.0KΩ	NORTH
BRIDGE	ALNICO 5 BEVELED	6.4 - 7.0KΩ	SOUTH