

# AMERICAN ELITE PRECISION® BASS (019690XXXX)

## PARTS LAYOUT

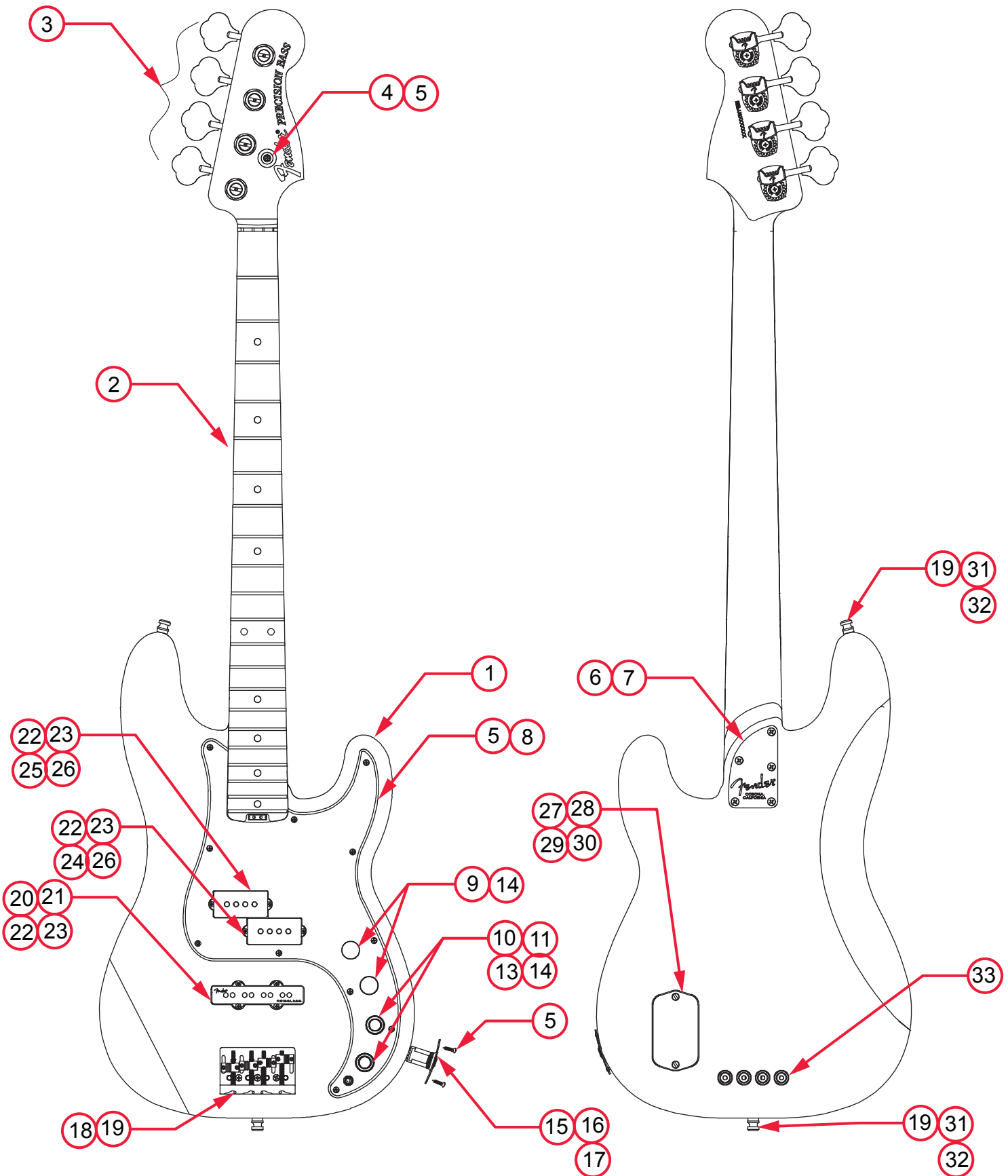

# AMERICAN ELITE PRECISION® BASS (019690XXXX)

## PARTS LIST

REF#	DESCRIPTION	PART NUMBER
1	BODY AM ELITE P-BASS 3TS	7708042500
1	BODY AM ELITE P-BASS OWT	7708492505
1	BODY AM ELITE P-BASS BLK	7708492506
1	BODY AM ELITE P-BASS NAT	7708365521
1	BODY AM ELITE P-BASS TBS	7708365552
2	NECK ASSY AM ELITE P-BASS RW	7708044000
2	NECK ASSY AM ELITE P-BASS MPL	7708043000
3	KEYS BASS FENDER DLX LONG CHROME	0097335049
4	STRING GUIDE P/J BASS CHROME	0079014000
5	SCREW SMAB 4 X 1/2 OHP NI	0015578049
6	NECK PLATE BASS 5-BOLT CHROME	0058329000
7	SCREW SMA 8 X 1-3/4 OHP NI	0015636049
8	PICKGUARD AM ELITE P-BASS MG/BLK/MG	7708502000
8	PICKGUARD AM ELITE P-BASS B/W/B	7708307000
9	KNOB CONTROL ALUM CHROME W/SET SCREW	0095799049
10	KNOB KNURLED UPPER CHROME	0049458000
11	SET SCREW 8-32 X 1/8 SL CUP NI	0050101049
12	KNOB KNURLED LOWER CHROME	0049457000
13	SET SCREW 8-32 X 3/16 SL CUP	0994922000
14*	PCB ASSY ELITE P-BASS W/ MTG HDWR	7708253000
15	JACK 6.3 OUTPUT	0073618000
16	FERRULE JACK RECESS FOOTBALL CHROME	0050100000
17*	WIRE HARNESS OUTPUT 4-PIN 24GA 9.5"	7708984000
18	BRIDGE ASSY HIGH MASS VINTAGE BASS CHROME	0075124000
18A	BASE PLATE HIGH MASS VINTAGE BASS CHROME	0075125000
18B	BLOCK HIGH MASS VINTAGE BASS CHROME	0075126000
18C	BRIDGE SADDLE HMV BASS 1-2	0075127000
18D	BRIDGE SADDLE HMV BASS 3-4	0075135000
18E	SCREW 6-32 X 5/16 FHP ZI	0076154000
18F	SCREW CAP 6-32 X 1-1/2 HEX SKT BLX	0075394000
18G	SPRING TELE BRIDGE BLACK	0018872049
18H	SCREW SET 6-32 X 7/16 HEX SKT BLX NYLOK	0075354000
19	SCREW SMAB 5 X 1 OHP NI	0015610049
20	PICKUP ASSY DLX NOISELESS J-BASS IV BRIDGE	7708441000
21	PICKUP COVER J-BASS IV DLX NOISELESS BRIDGE BLK	7708569020
22	WEATHERSTRIPPING 9/16 X 1/2 OP CL NEOP	0018556049

\*= NOT PICTURED IN DIAGRAM



# **AMERICAN ELITE PRECISION® BASS (019690XXXX)**

<b>REF#</b>	<b>DESCRIPTION</b>	<b>PART NUMBER</b>
23	SCREW 4 X 1-1/4 WOOD RD PH NI	0027035049
24	PICKUP ASSY P-BASS AM DLX BRIDGE GLOSS BLK	0079373000
25	PICKUP ASSY P-BASS AM ELITE NK GLOSS BLK	7709457000
26	COVER PICKUP P-BASS GLOSS BLACK	0992037000
27	COVER BACK DELUXE BASSES	0079370000
28	INSERT THREADED #6-32 PRESS IN	0078454000
29	SCREW SPECIAL 6-32 X 5/16 OHS ZA	0078432000
30	POWER 4-PIN HARNESS 24GA DIM BASS	7700192000
31	STRAP BUTTON STD/ELITE CHROME	0994914000
32	FELT WASHERS BLACK	0994929000
32	FELT WASHERS WHITE	0994930000
33	FERRULE STRING AS BASS	0048604049
*	CASE MOLDED AM ELITE BASS	7708556000
*	WRENCH 3/32 HEX KEY SHORT ARM	0018622000
*	WRENCH 1/16 HEX KEY SHORT ARM	0021109049
*	WRENCH HEX KEY 7/64 BALL END	0995504002

\*= NOT PICTURED IN DIAGRAM



# AMERICAN ELITE PRECISION® BASS (019690XXXX)

## WIRING ASSEMBLY

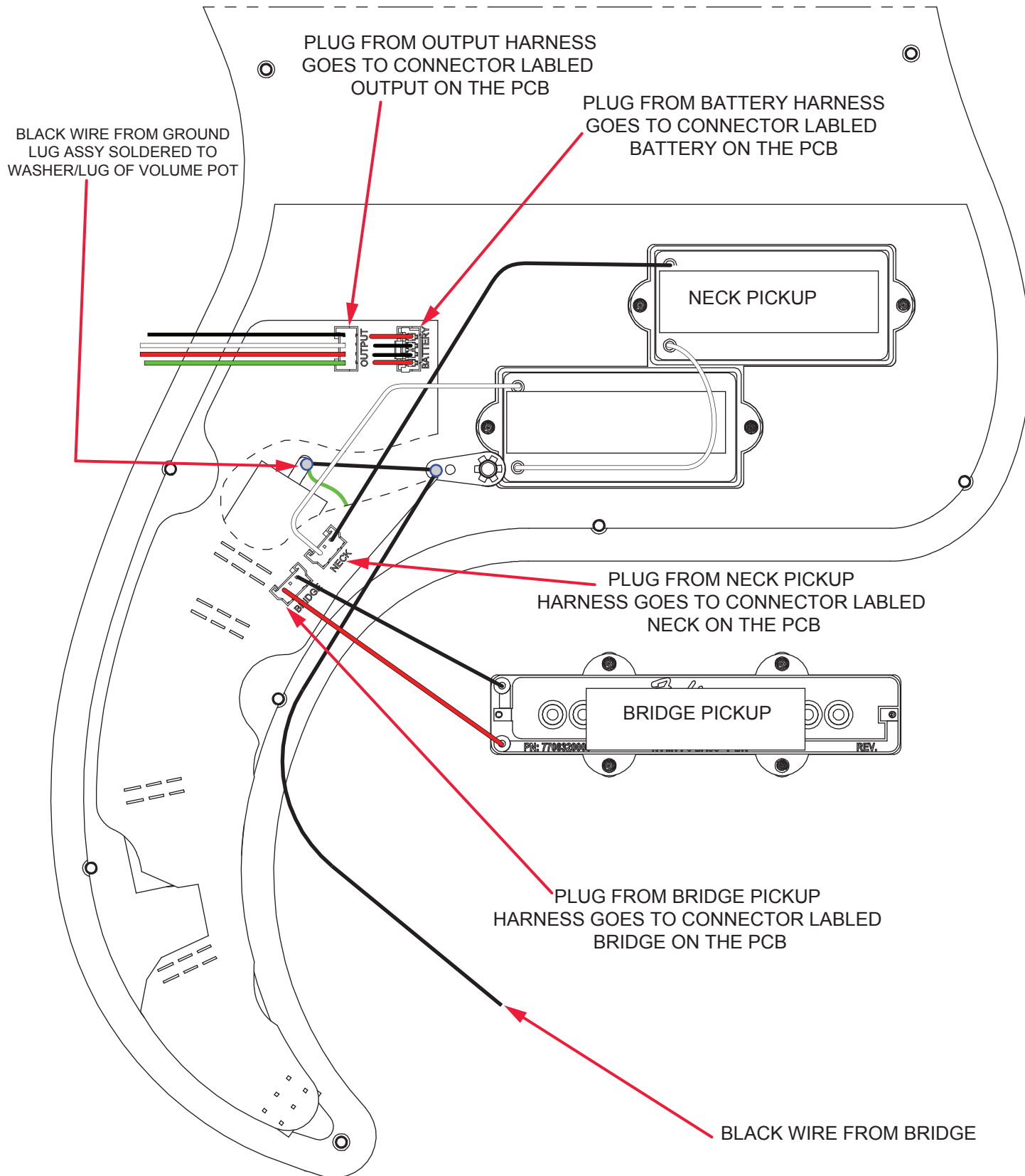

# AMERICAN ELITE PRECISION® BASS (019690XXXX)

## SWITCH AND CONTROL FUNCTION

SWITCH FUNCTION				
CONTROLS				SWITCH POSITION
TREBLE INNER	BASS OUTER	MIDRANGE INNER	PASSIVE TONE OUTER	
ON	ON	ON	OFF	ACTIVE
OFF	OFF	OFF	ON	PASSIVE

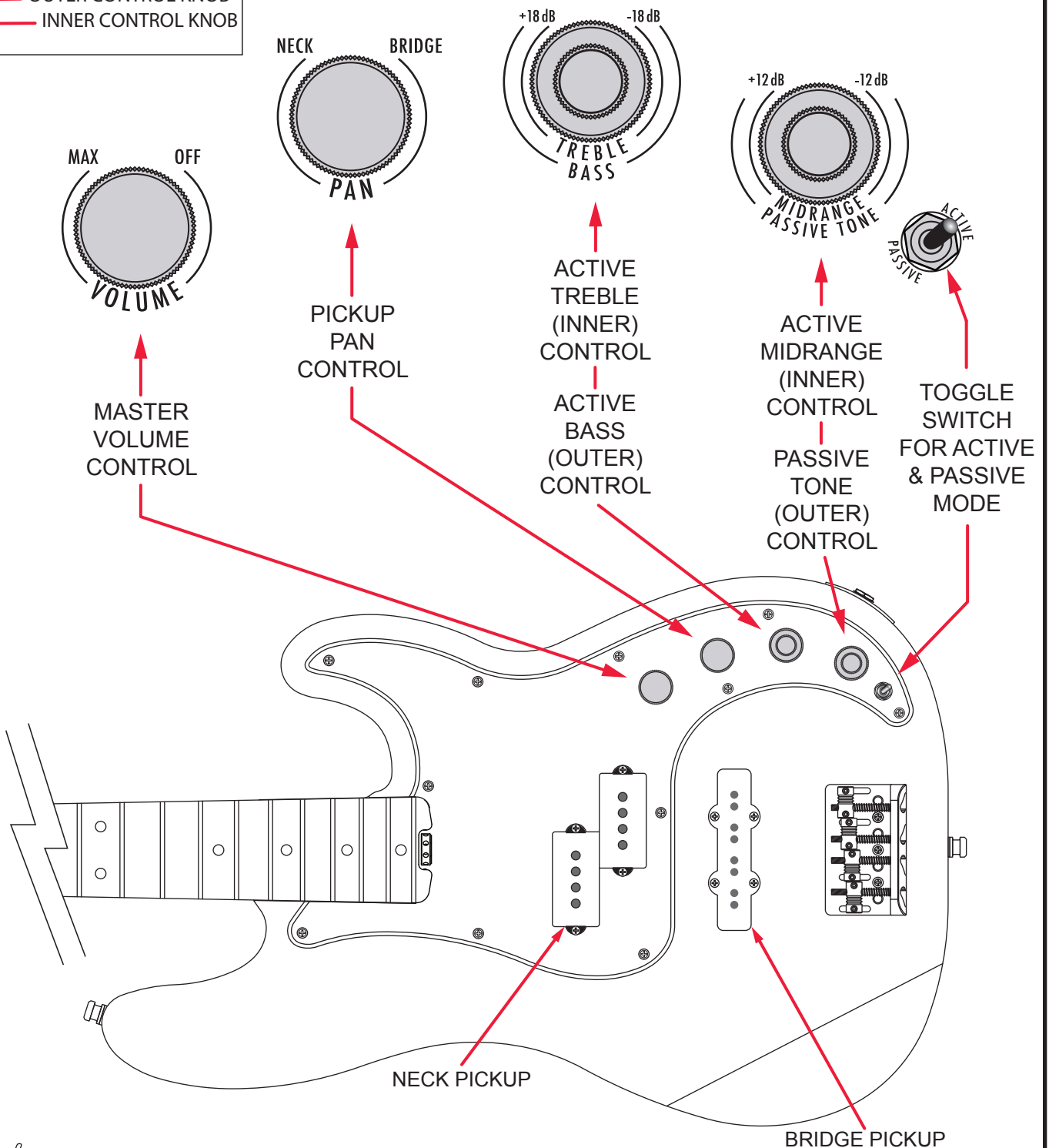
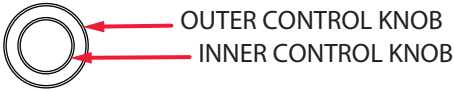

# AMERICAN ELITE PRECISION® BASS (019690XXXX)

## ADDITIONAL SPECIFICATION DETAIL

**FRET SIZE: MEDIUM JUMBO**  
(FRET DIMENSIONS ARE BEFORE INSTALLATION)

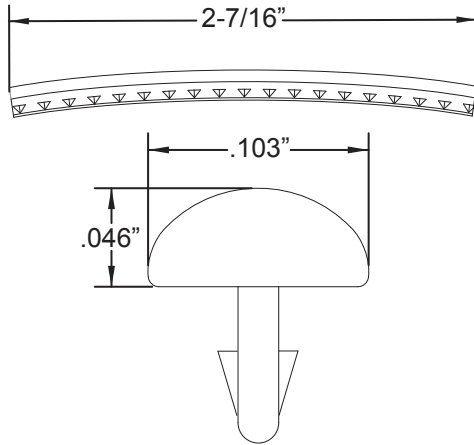

PLEASE NOTE: AS EACH NECK IS SANDED & FINISHED BY HAND, THICKNESS DIMENSIONS MAY VARY SLIGHTLY FROM THOSE SHOWN.

**NECK PROFILE: MODERN "C"**

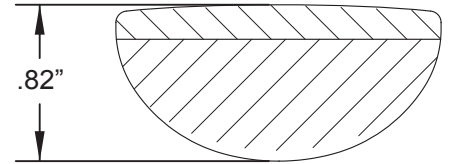

**1ST FRET PROFILE**

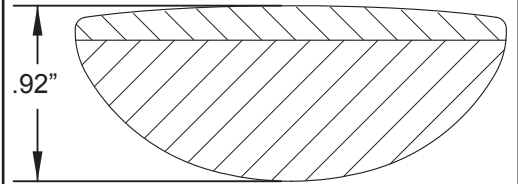

**12TH FRET PROFILE**

**STAGGERED TUNING MACHINES SET: P/N 0097335049**  
**OUTER SHAFT DIAMETER .533"**

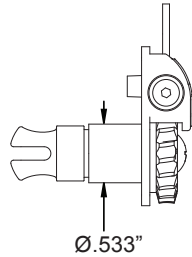

**TUNING MACHINE THRU-HOLE**  
**INNER DIAMETER .687"**

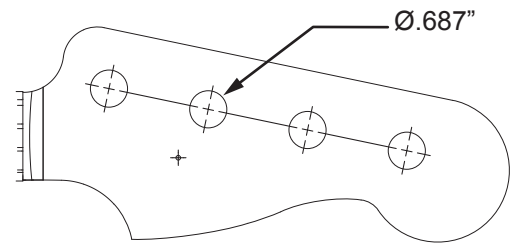

**SADDLE HEIGHT ADJUSTMENT WRENCH:**  
**1/16" HEX KEY P/N 0021109049**  
**SADDLE HEIGHT ADJUSTMENT SCREWS: P/N 0075354000**

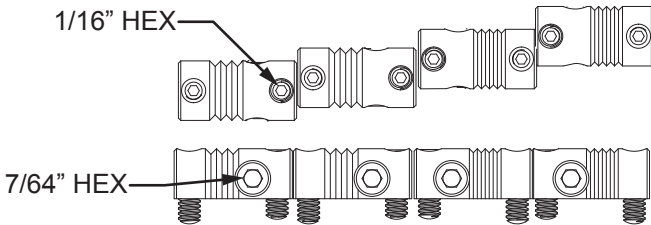

**INTONATION ADJUSTMENT WRENCH:**  
**7/64 HEX KEY P/N 0076157000**

**TRUSS ROD THUMB WHEEL:**  
**P/N 7708832000 GOLD - P/N 7708809000 BLACK**  
**TRUSS ROD ADJUSTMENT WRENCH:**  
**3/32" HEX KEY P/N 0018622000**

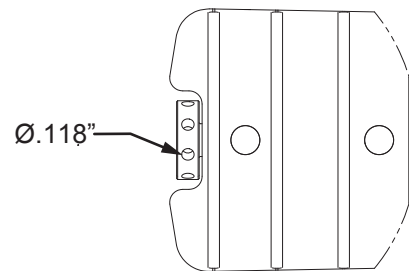

**LOGO: AM ELITE P-BASS DECAL**  
**APPLIED UNDER THE FINISH**

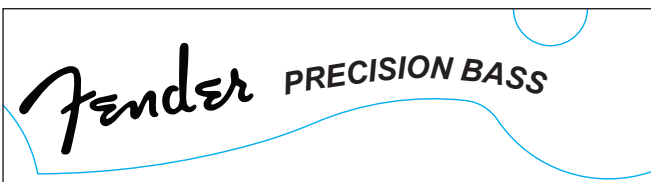

### PICKUP SPECIFICATIONS

POSITION	MAGNETS	DC RESISTANCE	POLARITY
NECK	ALNICO 5 UNBEVELED	5.0 - 5.5KΩ NORTH	
		5.0 - 5.5KΩ SOUTH	
BRIDGE	ALNICO 5 UNBEVELED	12.3 - 12.7KΩ	NORTH