

AMERICAN ORIGINAL 50'S TELECASTER® LH (0110133850)

PARTS LAYOUT

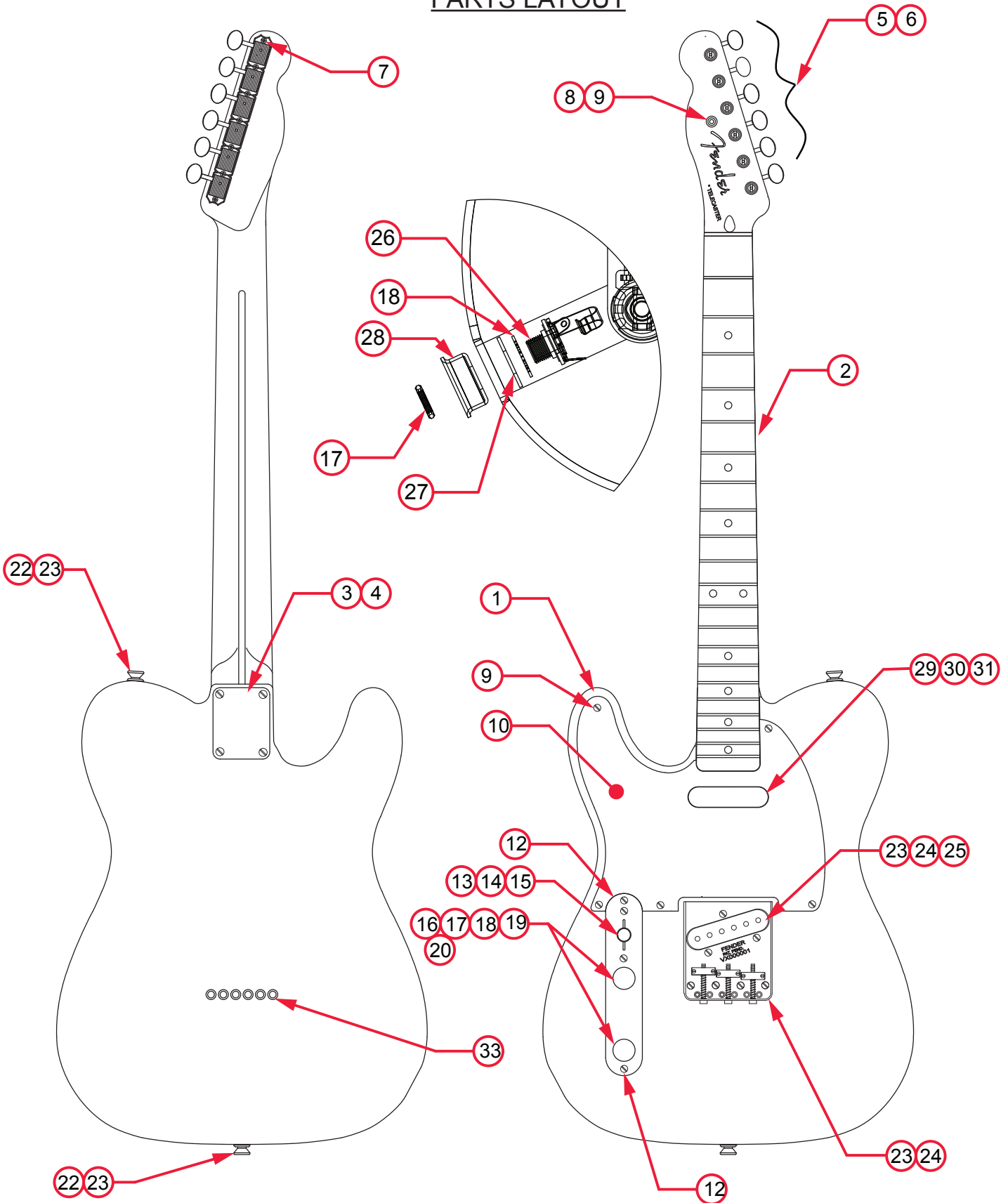

AMERICAN ORIGINAL 50'S TELECASTER® LH (0110133850)

PARTS LIST

REF#	DESCRIPTION	PART NUMBER
1	BODY AM ORIGINAL 50'S TELE LH BTB	7711114550
2	NECK ASSY AM ORIGINAL 50'S TELE MPL	7710936000
3	PLATE NECK VINTAGE TELE CHROME	0018353000
4	SCREWS SMA 8 X 1-3/4 OHS NI	0018369049
5	KEY GTR NI FENDER LOGO SET	0091059060
6	BUSHING STRING POST VINT	0994946000
7	SCREW SMA 3 X 3/8 OHS NI	0018370049
8	STRING GUIDE VINT TELE W/HDWR	0994912000
9	SCREW SMA 4 X 1/2 OHS NI	0018368049
10	PICKGUARD TELE VINT 1-PLY BLACK	0053821000
11	PLATE CONTROL TELE VINT CRS CHRM	0093607000
12	SCREWS WD 5 X 5/8 OHS NI	0095368049
13	SWITCH 3-WAY LEVER	0038993049
14	SCREW M 6-32 X 3/8 RHS NI	0018375049
15	KNOB SWITCH VINT TELE BAKELITE	0093602049
16	KNOB 52 TELE KNURLED UPG CHR	0094040049
17	NUT HEX 3/8-32 X 3/32 TK NI	0016352049
18	WASHER LOCK INTL 3/8 X .687	0016436049
19	CONTROL 250K 10% AUDIO METAL	0990831000
20	CAP WAX PAPER .05µF 150V	0096454049
21A	BRIDGE SECTION VINTAGE TELE	0018360000
21B	SPRING COMPRESSION 1-1/16 #144	0018689049
21C	SCREW ST 6-32 X 3/8 OVPT SL NI	0094038000
21D	SCREW ST 6-32 X 7/16 OVPT SL NI	0016105049
21E	SCREW M 6-32 X 1-1/4 FLHS NI	0018377049
22	SCREW WD 6 X 1 OHS NI	0018371049
23	PICKUP ASSY 52 TELE BRIDGE	0094123000
24	SCREW M 6-32 X 5/8 RHS NI	0018376049
25	TUBING LATEX CUT .375 X 1/8ID X 1/4OD	0036878000
26	JACK PHONE OPEN CIRCT 11	0021956049
27	RETAINER JACK NI	0010355069
28	FERRULE JACK STD TELE NICKEL	0010363070
29	PICKUP ASSY 52 TELE NECK	0094124000
30	TUBING LATEX CUT .550 x 1/8	0039410000
31	SCREWS WD 3x1 RHS NI	0018373049

*= NOT PICTURED IN DIAGRAM



AMERICAN ORIGINAL 50'S TELECASTER® LH (0110133850)

REF#	DESCRIPTION	PART NUMBER
32	STRAP BUTTONS NI .156	0994915000
33	FERRULES STRING RETAINER NI	0994918000
*	CASE STRAT/TELE TWEED	0047366011

*= NOT PICTURED IN DIAGRAM



AMERICAN ORIGINAL 50'S TELECASTER® LH (0110133850)

WIRING ASSEMBLY

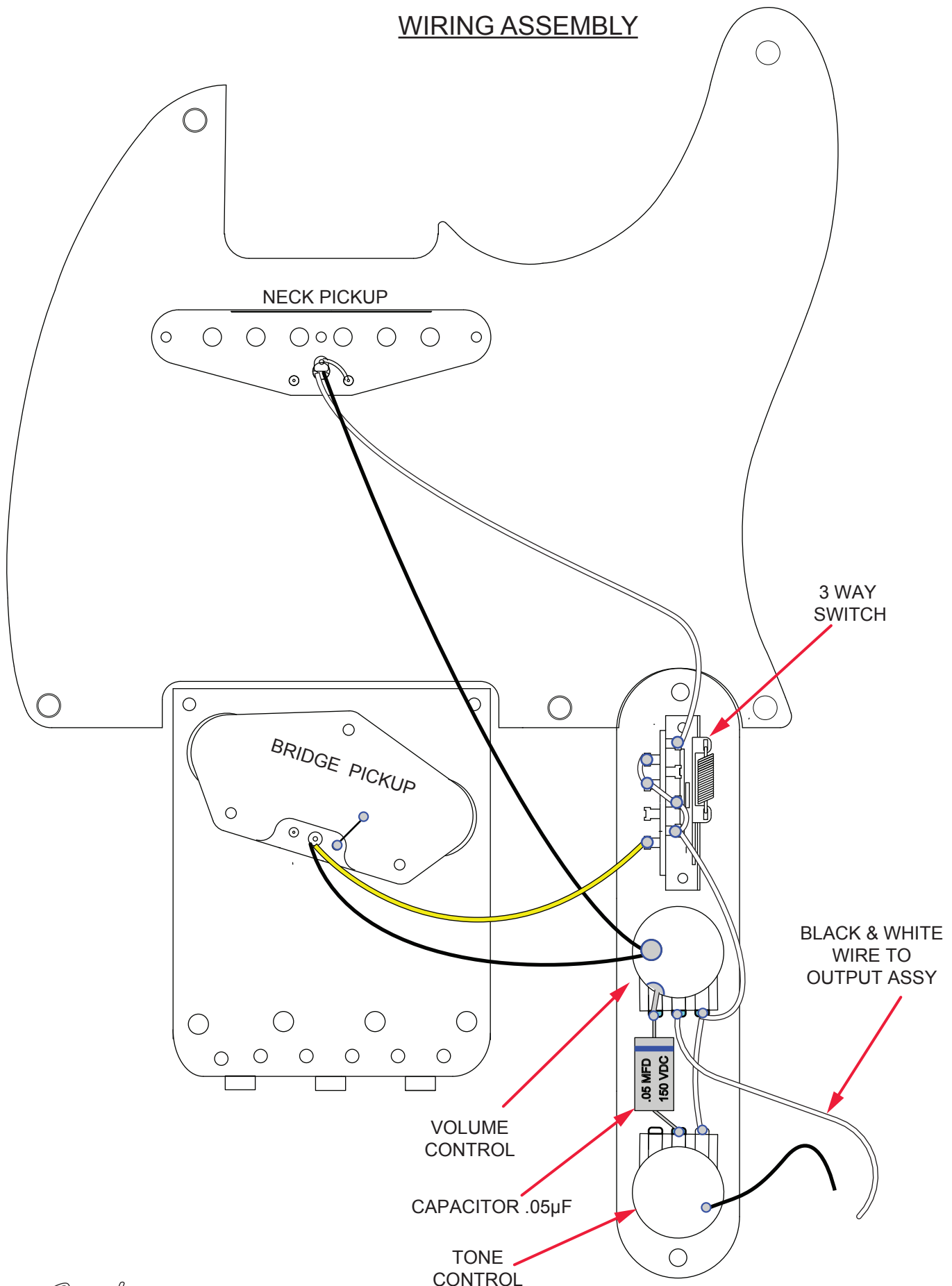

AMERICAN ORIGINAL 50'S TELECASTER® LH (0110133850)

SWITCH AND CONTROL FUNCTION

3 WAY SWITCH POSITION			
			← 3 WAY SWITCH POSITION
			← NECK PICKUP
			← BRIDGE PICKUP
	PICKUP IS ON		INDICATES POSITION OF 3 WAY SWITCH
	PICKUP IS OFF		

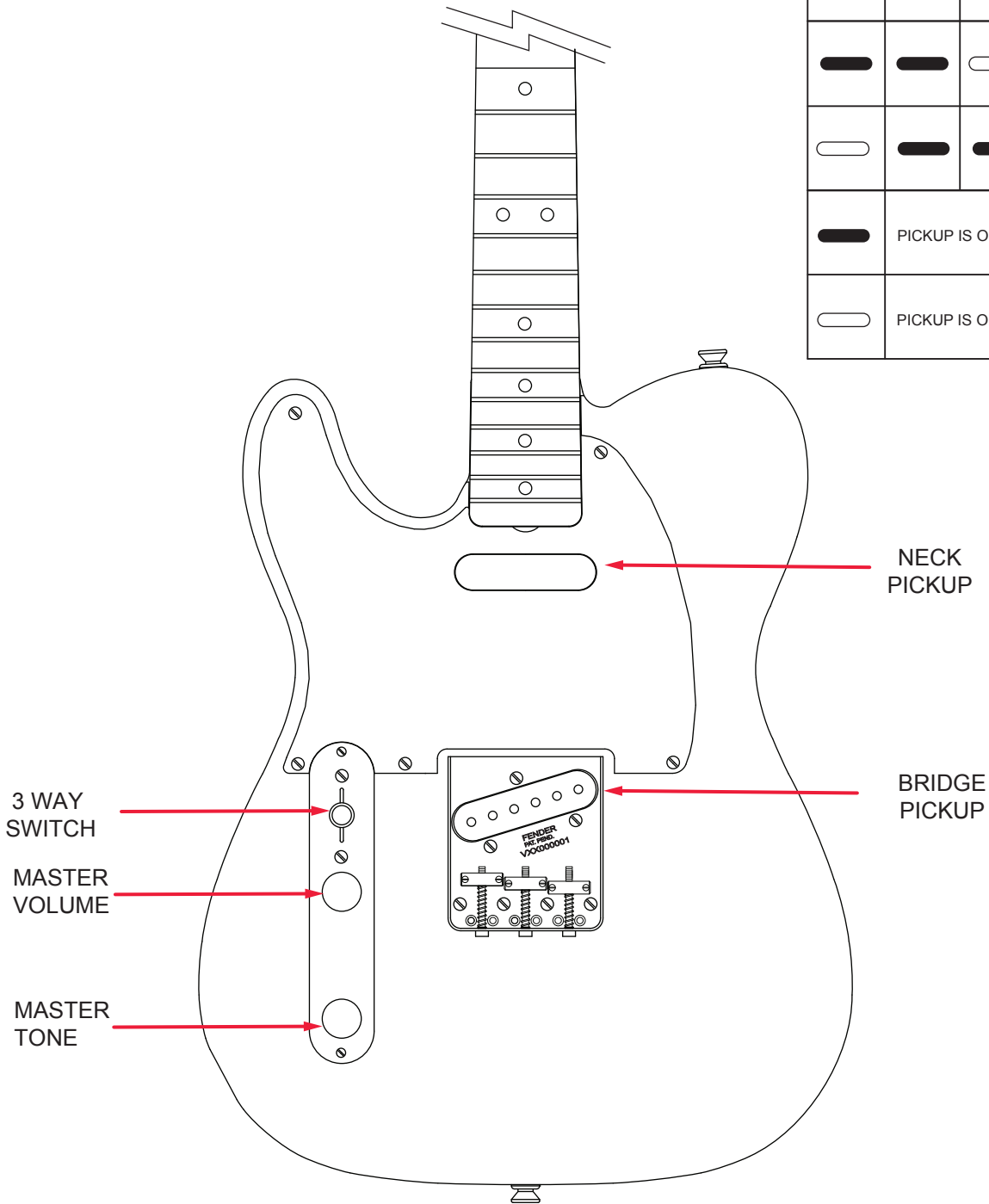

AMERICAN ORIGINAL 50'S TELECASTER® LH (0110133850)

ADDITIONAL SPECIFICATION DETAIL

FRET SIZE: VINTAGE
(FRET DIMENSIONS ARE BEFORE INSTALLATION)

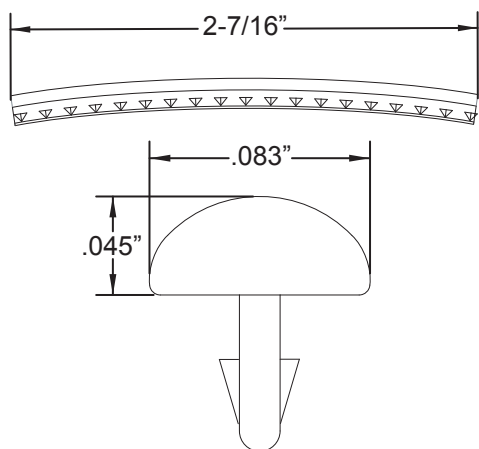

PLEASE NOTE: AS EACH NECK IS SANDED & FINISHED BY HAND, THICKNESS DIMENSIONS MAY VARY SLIGHTLY FROM THOSE SHOWN.

NECK PROFILE: VINTAGE "U" SHAPE

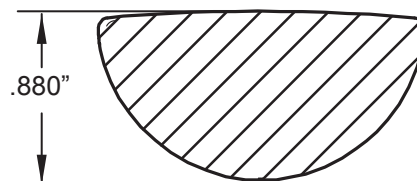

1ST FRET PROFILE

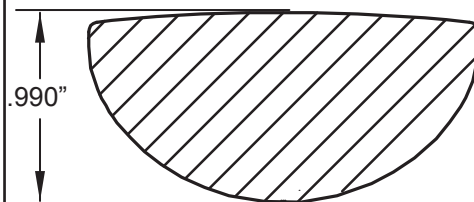

12TH FRET PROFILE

STAGGERED TUNING MACHINE SET W/HDWR P/N 0992074000
OUTER SHAFT DIAMETER .250"

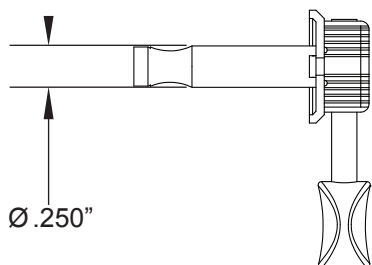

TUNING MACHINE THRU-HOLE
INNER DIAMETER .261"

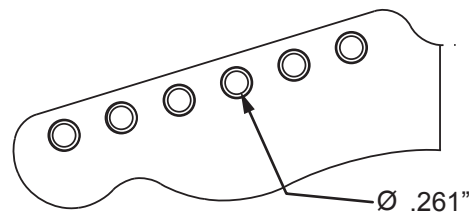

SLOTTED
SET SCREW

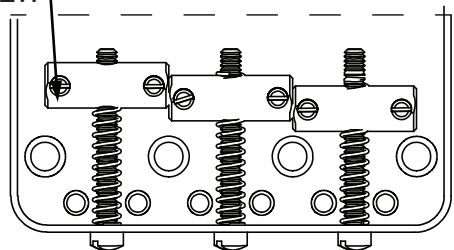

SADDLE HEIGHT SET SCREWS SLOTTED

TALL: P/N 0016105049

SHORT: P/N 0094038000

TRUSS ROD NUT P/N 0994944000

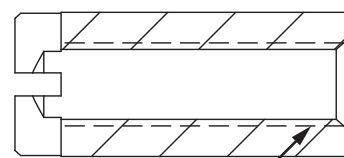
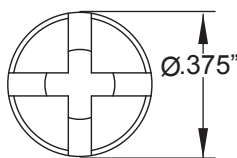

10-32
THREAD

LOGO: VINTAGE TELE
APPLIED OVER FINISH



PICKUP SPECIFICATIONS

POSITION	MAGNETS	DC RESISTANCE	POLARITY
NECK	ALNICO 3	6.5 - 7.9Ω	NORTH
BRIDGE	ALNICO 3	6.0 - 7.2KΩ	NORTH