

# AMERICAN ORIGINAL 60'S STRATOCASTER® LH (0110121805)

## PARTS LAYOUT

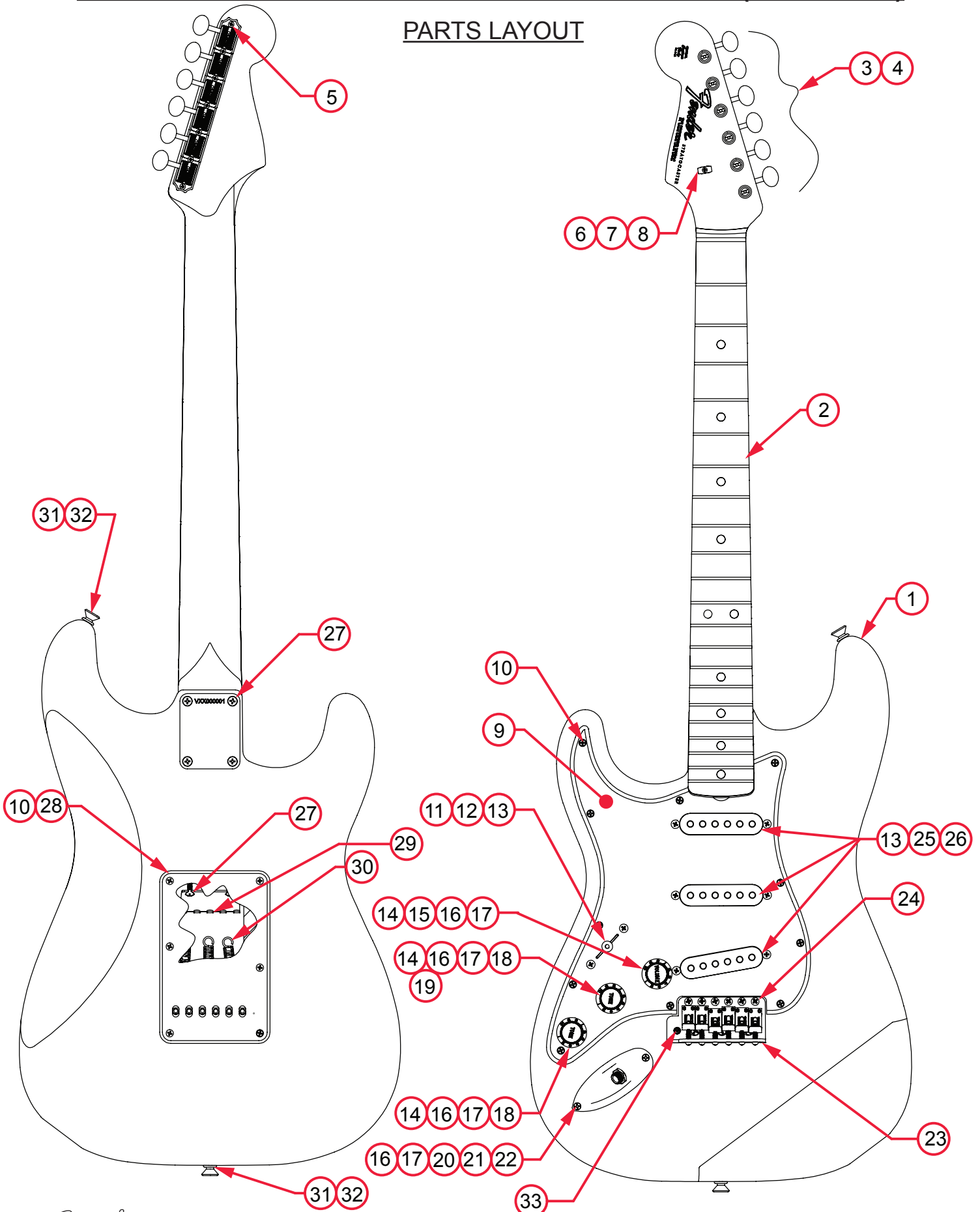

# AMERICAN ORIGINAL 60'S STRATOCASTER® LH (0110121805)

## PARTS LIST

REF#	DESCRIPTION	PART NUMBER
1	BODY AM ORIGINAL 60'S STRAT LH OLW	7711112505
2	NECK AM ORIGINAL 60'S STRAT LH RW	7710940000
3	KEY GUITAR NI W/FENDER LOGO SET LH W/HDWR	0992074002
4	BUSHING STRING POST VINTAGE	0994946000
5	SCREW SMAB 3 X 3/8 RHP NI	0011357049
6	STRING TREE VINTAGE NI W/HDWR	0994910000
7	STRING TREE SPACER 65 STRAT NYLON	0093999000
8	SCREW SMA 3 X 5/8 RHP NI	0011358049
9	PICKGUARD 65 STRAT LH MG/BLK/MG	7711943000
10	SCREW SMAB 4 X 1/2 OHP NI	0015578049
11	5 WAY LEVER SWITCH	0038929049
12	SWITCH LEVER KNOB VINTAGE STRAT NYL AGED WHITE	0994938000
13	SCREW M 6-32 X 5/8 OHP NI	0015776049
14	CONTROL 250K 10% TPR SPLIT	0990830000
15	KNOBS STRAT AGED WHITE SET (1-VOL 2-TONE)	0991369000
16	NUT HEX 3/8-32 X 3/32 TK NI	0016352049
17	WASHER LOCK INTL 3/8 X .687	0016436049
18	KNOBS STRAT AGED WHITE SET (1-VOL 2-TONE)	0991369000
19	CAPACITOR CERAMIC DISC .1µF 150V	0094393000
20	FERRULE JACK CHROME	0991940100
21	JACK PHONE CIRCT 11	0021956049
22	SCREW SMA 5 X 5/8 OHP NI	0015602049
23	BRIDGE ASSY AM VINT STRAT LH	0094279000
23A	BRIDGE PLATE VINTAGE STRAT LH	0040851000
23B	BRIDGE BLOCK VINTAGE STRAT LH	0038962000
23C	BRIDGE SECTION ASSY AM VINTAGE NI TALL	0093568102
23D	BRIDGE SECTION ASSY AM VINTAGE NI SHORT	0093568101
23E	SCREW M 4-40 X 5/8 RHP NI	0015693049
23F	SPRING BRIDGE 7/16 9 COIL	0094278000
23G	SPRING BRIDGE #1932	0019281049
23H	SPRING BRIDGE 3/8 7 COIL	0094277000
23I	SCREW M 8-32 X 3/8 FHP NI	0019656049
24	SCREW WOOD RD PH 6 X 1-1/4 NI	0016170049
25	PICKUP ASSY 65 STRAT LH AGED WHITE	7711761000

\*= NOT PICTURED IN DIAGRAM





# AMERICAN ORIGINAL 60'S STRATOCASTER® LH (0110121805)

## WIRING ASSEMBLY

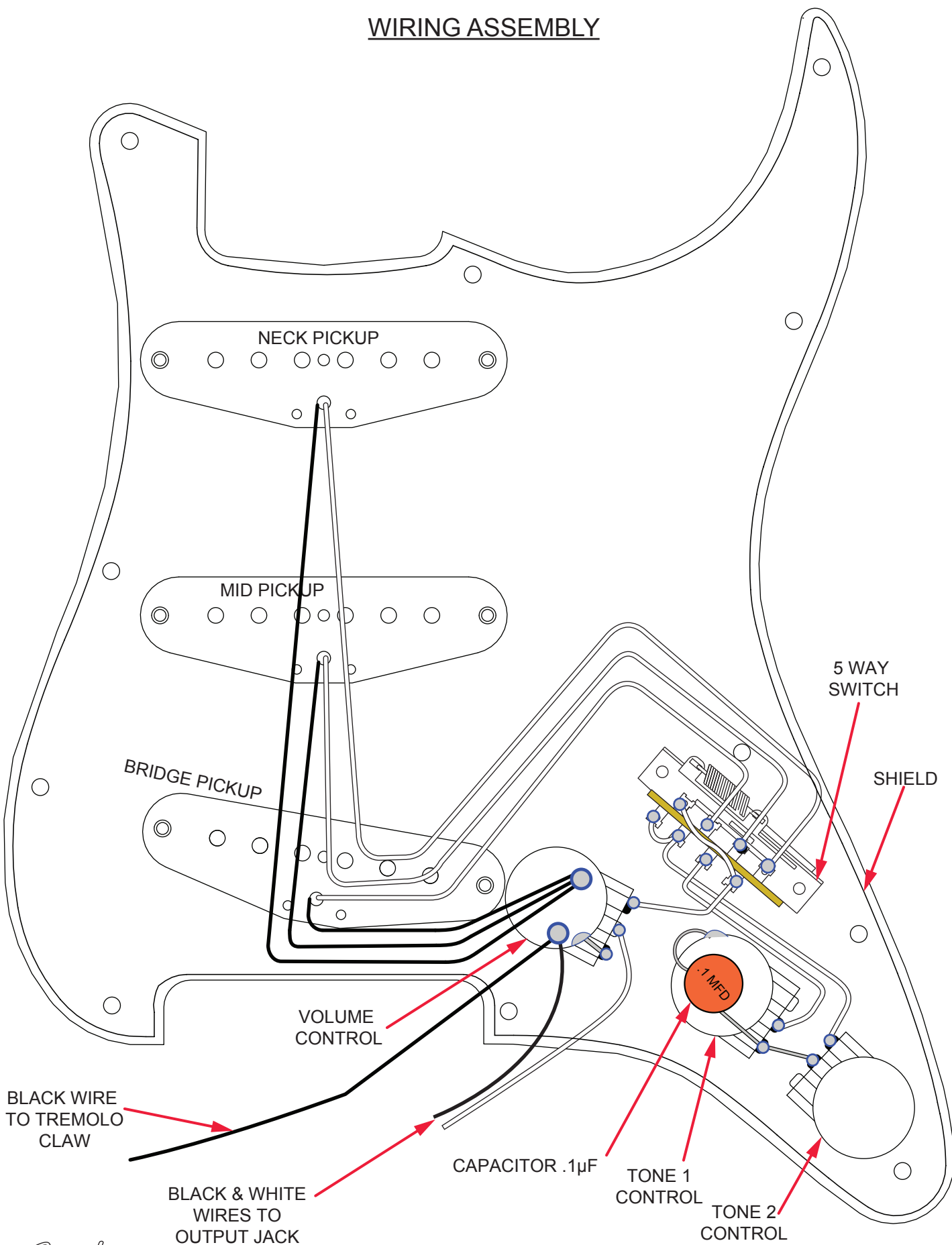

# AMERICAN ORIGINAL 60'S STRATOCASTER® LH (0110121805)

## SWITCH AND CONTROL FUNCTION

5 WAY SWITCH POSITION					
					SWITCH POSITION
T1	T1 & T2	T2	T2	T2	← TONE CONTROL
					← NECK PICKUP
					← MIDDLE PICKUP
					← BRIDGE PICKUP
PICKUP IS ON	INDICATES POSITION OF 5 WAY SWITCH				
PICKUP IS OFF					

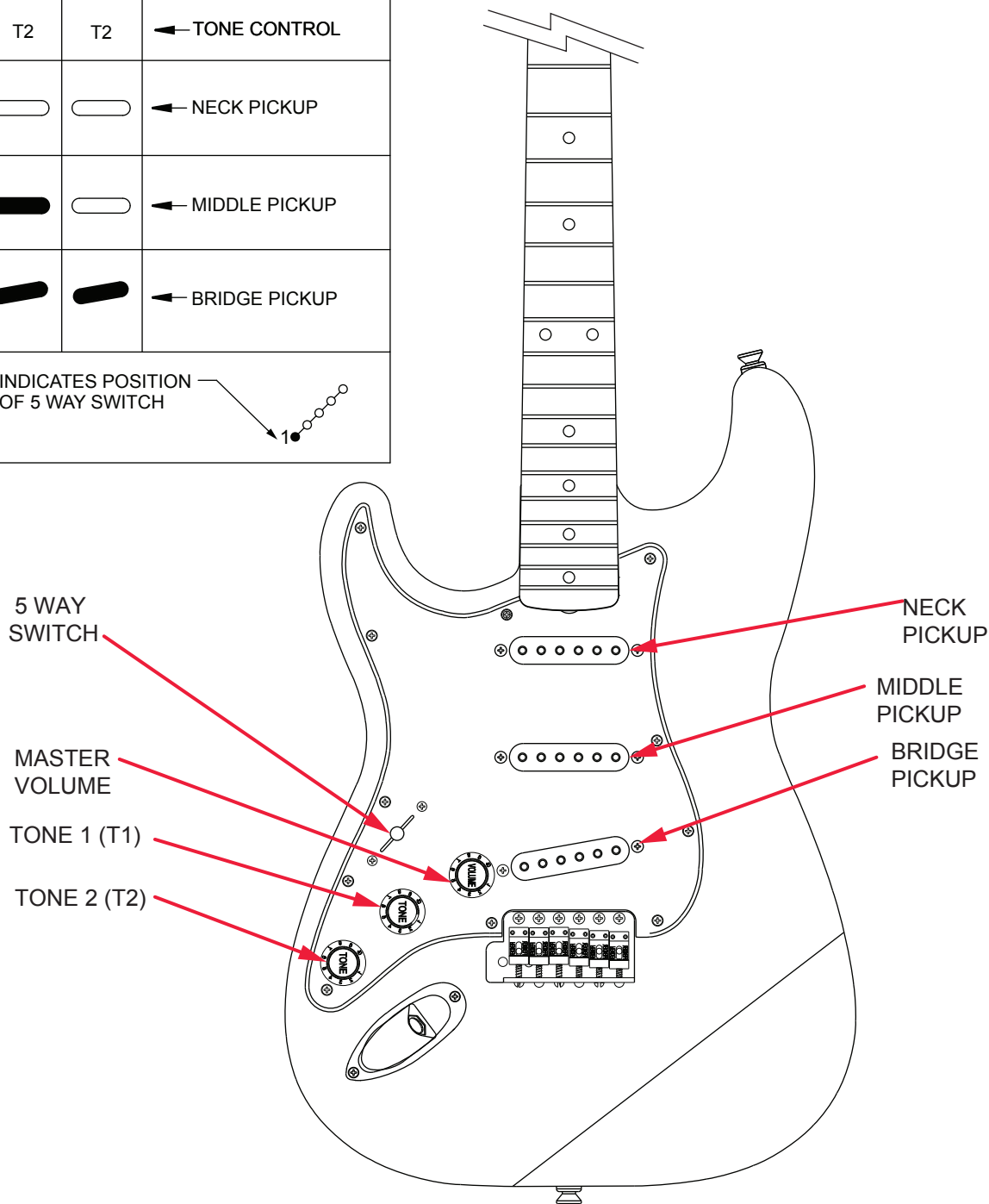

# AMERICAN ORIGINAL 60'S STRATOCASTER® LH (0110121805)

## ADDITIONAL SPECIFICATION DETAIL

**FRET SIZE: VINTAGE**  
(FRET DIMENSIONS ARE BEFORE INSTALLATION)

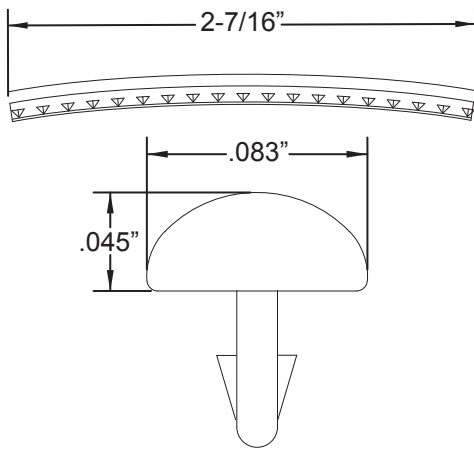

PLEASE NOTE: AS EACH NECK IS SANDED & FINISHED BY HAND, THICKNESS DIMENSIONS MAY VARY SLIGHTLY FROM THOSE SHOWN.

**NECK PROFILE: MID 60'S "C"**

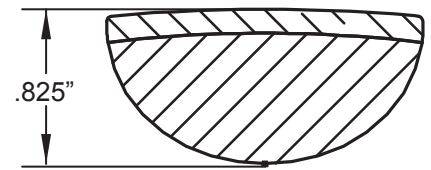

1ST FRET PROFILE

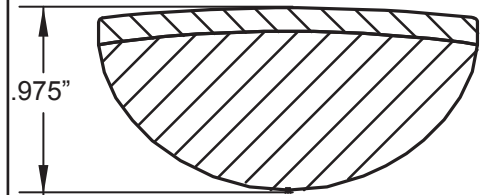

12TH FRET PROFILE

**STAGGERED TUNING MACHINE SET W/HDWR P/N 0992074002**  
**OUTER SHAFT DIAMETER .250"**

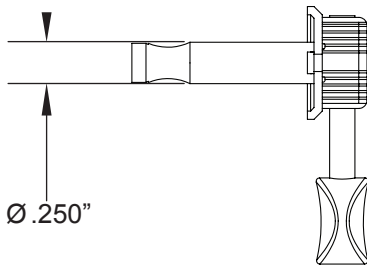

**TUNING MACHINE THRU-HOLE**  
**INNER DIAMETER .261"**

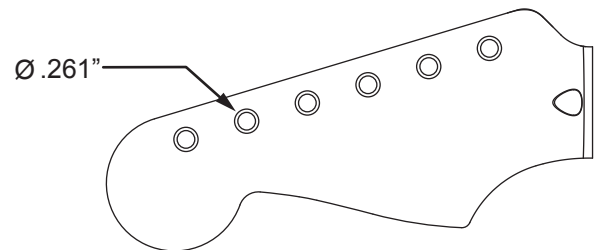

**SADDLE HEIGHT ADJUSTMENT WRENCH:**  
**.050" HEX KEY P/N 0018531049**

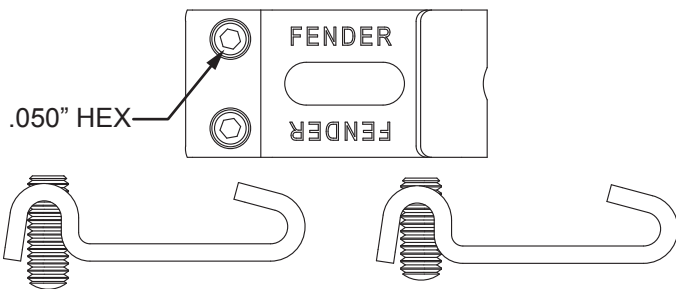

**SADDLE HEIGHT ADJUSTMENT SCREWS:**  
TALL: P/N 0075384000      SHORT: P/N 0075536000

**TRUSS ROD NUT P/N 0058171000**

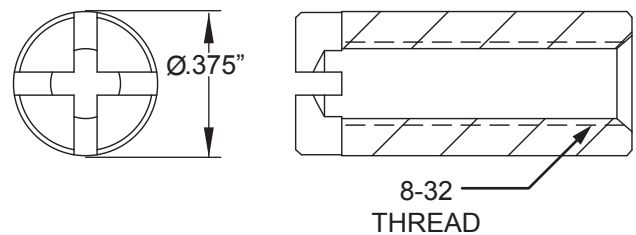

**LOGO: VINTAGE STRATOCASTER UPG**  
**APPLIED OVER THE FINISH**



**PICKUP SPECIFICATIONS**

POSITION	MAGNETS	DC RESISTANCE	POLARITY
NECK	ALNICO 5 UNBEVELED	5.7 - 6.1KΩ	SOUTH
MIDDLE	ALNICO 5 UNBEVELED	5.7 - 6.1KΩ	SOUTH
BRIDGE	ALNICO 5 UNBEVELED	5.7 - 6.1KΩ	SOUTH