

LTD ED TELECASTER THINLINE SUPER DELUXE (0176042722)

PARTS LAYOUT

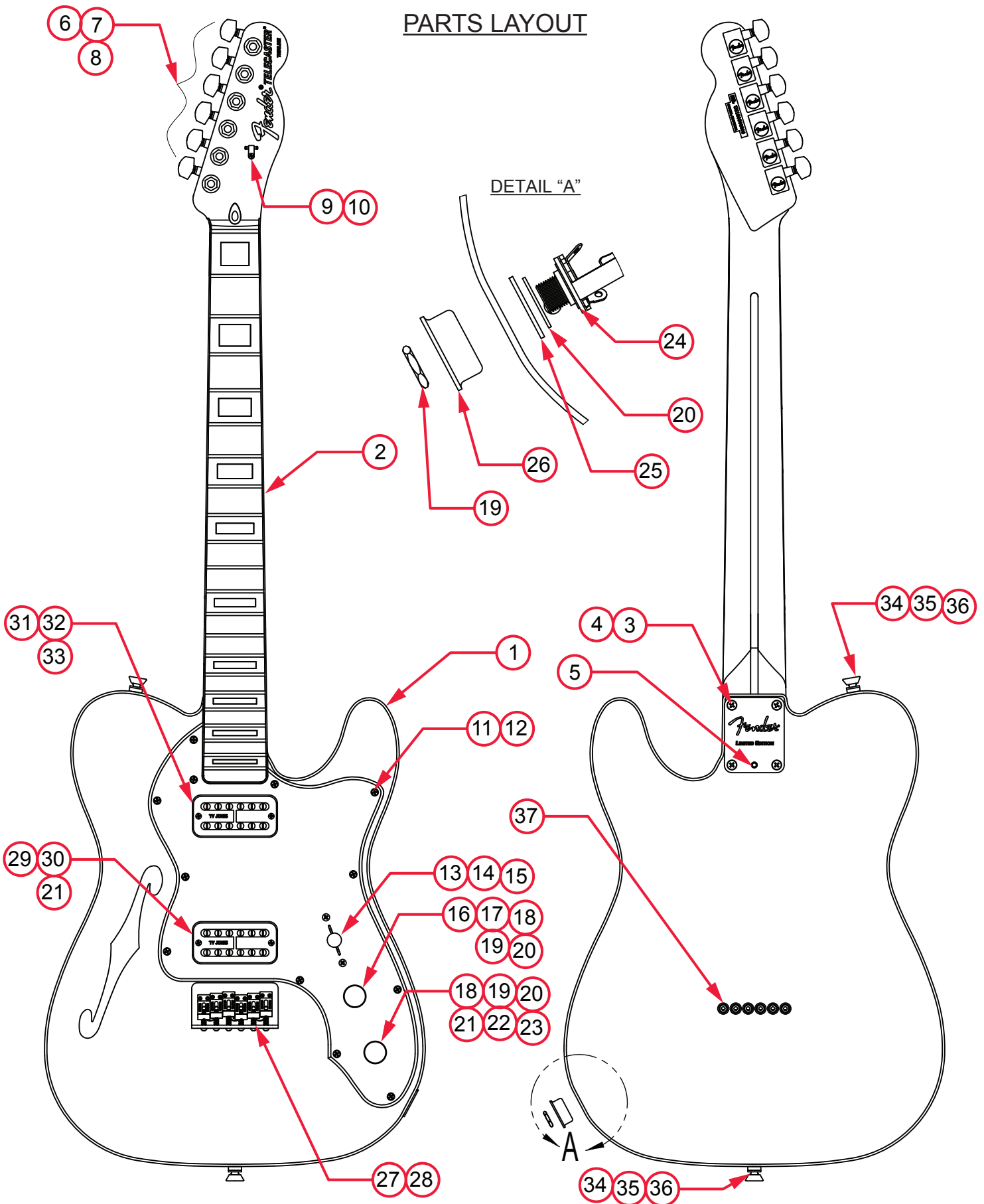

LTD ED TELECASTER THINLINE SUPER DELUXE (0176042722)

PARTS LIST

REF#	DESCRIPTION	PART NUMBER
1	BODY TELE THINLINE SUPER DLX ORG	7712111522
2	NECK ASSY TELE THINLINE SUPER DLX RW	7712091000
3	NECK PLATE LTD ED ALUM CHR W/TILT	7711588000
4	SCREW SMA 8 X 1-3/4 OHP NI	0015636049
5	SET SCREW 1/4-20 X 3/8 OP NI HEX	0031571049
6	KEYS GUITAR DUAL PIN MTG SET W/HDWR	0990820100
7	WASHERS KEY	0053106049
8	BUSHINGS KEY	0058820049
9	STRING GUIDE TREE AM STD W/HDWR	0994911000
10	SCREW SMAB 3 X 3/8 RHP STL NI	0011357049
11	PICKGUARD TELE SUPER DLX SILVER SPARKLE	7712112000
12	SCREW SMAB 4 X 1/2 OHP NI	0015578049
13	SWITCH 3-WAY LEVER	0992041000
14	SCREW MACH 6-32 X 5/8 NI	0994925000
15	KNOB SWITCH VINT TELE	0994936000
16	CONTROL 500K A-TAPER .25 X .625 S-SHAFT	0079409000
17	PCB ASSY TREB BLEED AM PRO TELE DLX	7711094000
18	KNOBS CONTROL ALUM CHR	0095799049
19	NUT HEX 3/8-32 X 3/32 TK NI	0016352049
20	WASHER LOCK INTL 3/8 X .687	0016436049
21	CONTROL 1-MEG 10% AUDIO METAL	0019066049
22	CAPACITOR CD 2000 PF 20%	0023257000
23	RESISTOR CF 1/4W 560K 5%	0025066001
24	JACK PHONE OPEN CIRCUIT 11	0021956049
25	RETAINER JACK NI PLT TELE	0010355069
26	FERRULE JACK STD TELE CHROME	0021452000
27	BRIDGE ASSY AM STD TELE NON TREM HH	7707357000
27A	BRIDGE PLATE AM STD NON TREM HH CHR	7707356000
27B	BRIDGE SECTION ASSY NI AS STRAT TALL	0075123102
27C	BRIDGE SECTION ASSY NI AS STRAT SHORT	0075123103
27D	SCREW MACH 4-40 X 5/8 RHP NI	0015693049
27E	SPRING BRIDGE 1933 1/4"	0019273049
27F	SPRING BRIDGE 1932 5/16"	0019273049
28	SCREW SMA 8 X 1 OHP NI	0021373049
29	PICKUP TVCN CHROME BRIDGE	0062291000
30	WEATHERSTRIP 3/8 X 3/8 OP CL NEOPRENE	0017333049

*= NOT PICTURED IN DIAGRAM



LTD ED TELECASTER THINLINE SUPER DELUXE (0176042722)

REF#	DESCRIPTION	PART NUMBER
31	SCREW WOOD RND HD 3 X 1 NI	0059185000
32	PICKUP TVCN CHROME NECK	0062292000
33	WEATHERSTRIP 9/16 X 1/2 OP CL NEOPRENE	0018556049
34	STRAP BUTTOM CHROME W/HDWR	0063267049
35	WASHERS FELT WHITE	0994930000
36	SCREW WOOD 6 X 1 OHP NI	0016188049
37	FERRULES STRING RETAINER NI SET	0994918000
*	CASE MOLDED AM ELITE GUITAR	7708545000
*	WRENCH HEX KEY 1/16 (BRIDGE SADDLE HEIGHT)	0021109049
*	WRENCH HEX KEY 1/8 (TRUSS ROD ADJUSTMENT)	0023811049

* = NOT PICTURED IN DIAGRAM







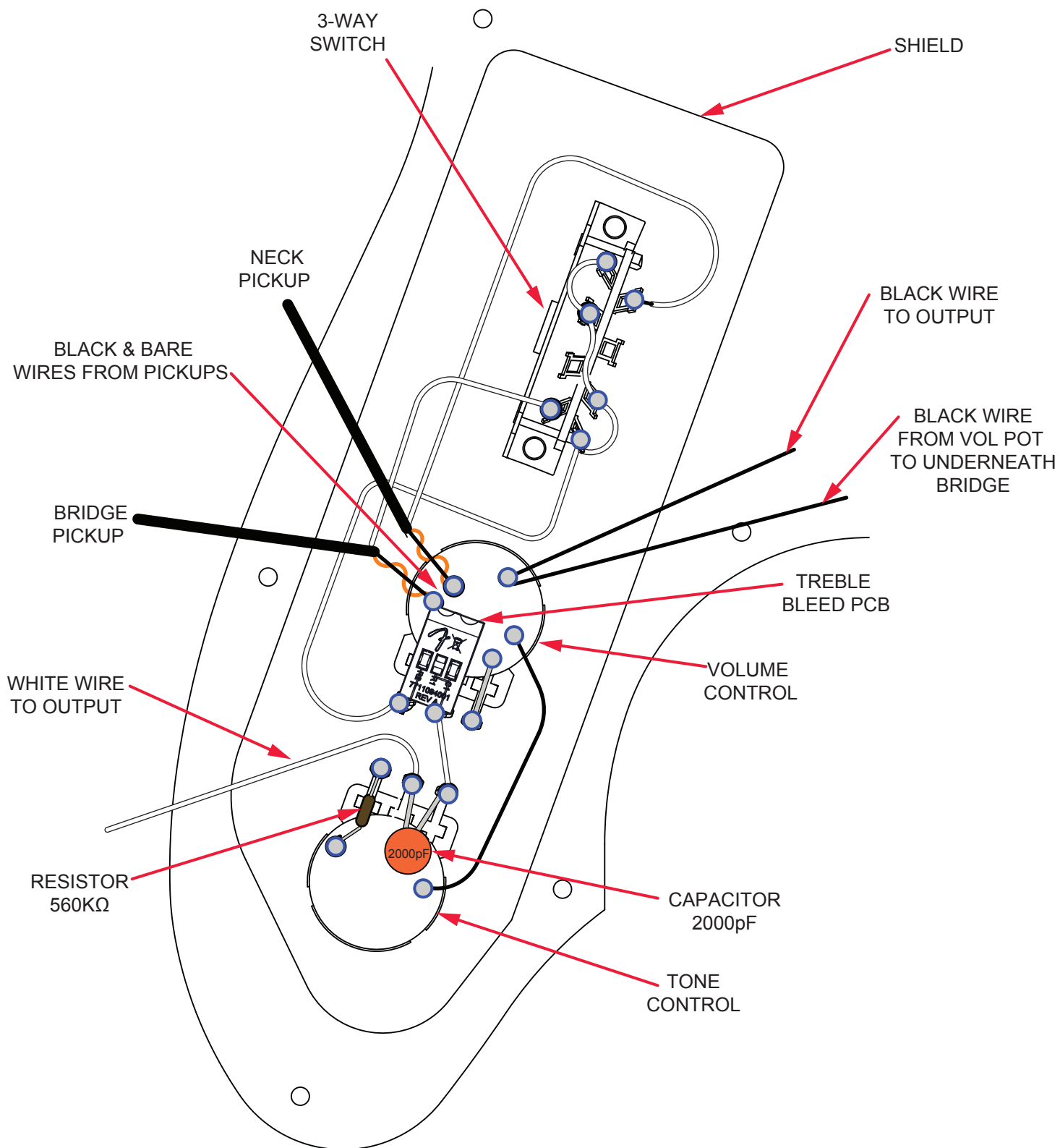





LTD ED TELECASTER THINLINE SUPER DELUXE (0176042722)

WIRING ASSEMBLY



LTD ED TELECASTER THINLINE SUPER DELUXE (0176042722)

SWITCH AND CONTROL FUNCTION

3 WAY SWITCH POSITION			
			← 3 WAY SWITCH POSITION
			← NECK PICKUP
			← BRIDGE PICKUP
			PICKUP IS ON
			PICKUP IS OFF

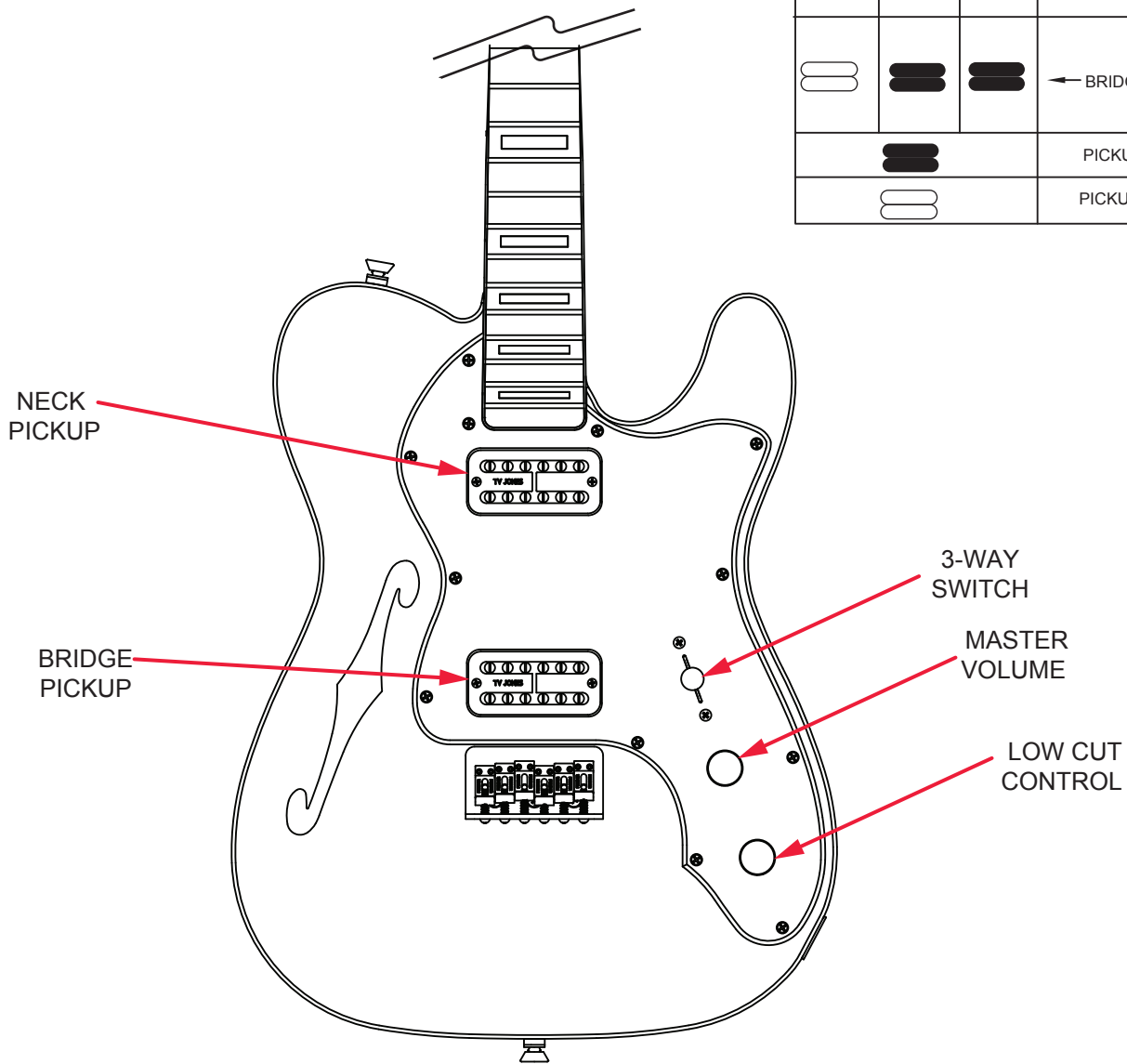

LTD ED TELECASTER THINLINE SUPER DELUXE (0176042722)

ADDITIONAL SPECIFICATION DETAIL

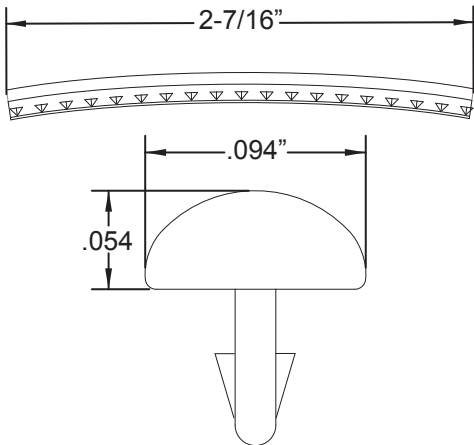
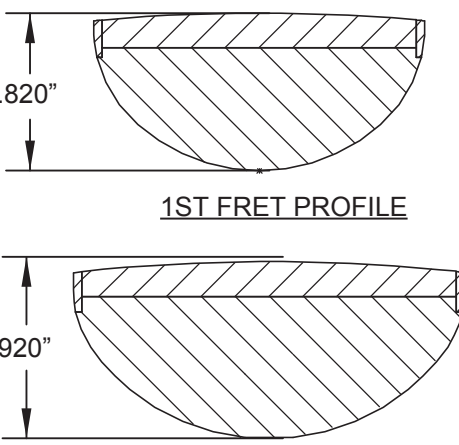
<p>FRET SIZE: JUMBO NARROW (FRET DIMENSIONS ARE BEFORE INSTALLATION)</p> 	<p>PLEASE NOTE: AS EACH NECK IS SANDED & FINISHED BY HAND, THICKNESS DIMENSIONS MAY VARY SLIGHTLY FROM THOSE SHOWN.</p>	<p>NECK PROFILE: DEEP "C"</p>  <p style="text-align: center;">1ST FRET PROFILE</p> <p style="text-align: center;">12TH FRET PROFILE</p>
---	---	---

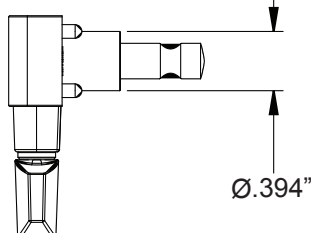
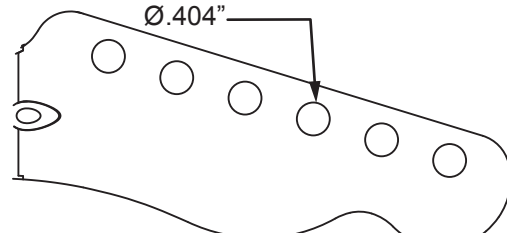
<p>STAGGERED LOCKING TUNING MACHINES SET: P/N 0990820100 OUTER SHAFT DIAMETER .394"</p> 	<p>TUNING MACHINE THRU-HOLE INNER DIAMETER .404"</p> 
--	--

SADDLE HEIGHT ADJUSTMENT WRENCH:
.1/16" HEX KEY P/N 0021109049

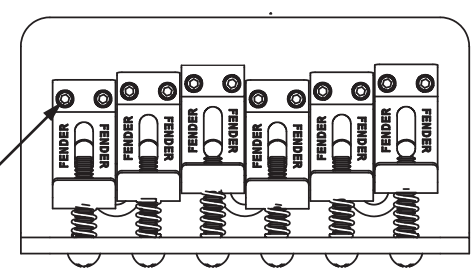

SADDLE HEIGHT ADJUSTMENT SCREWS:
TALL 3/8": P/N 0075385049 SHORT 5/16": P/N 0075384049

TRUSS ROD NUT: P/N 0994943000
TRUSS ROD ADJUSTMENT WRENCH:
1/8" HEX KEY P/N 0023811049

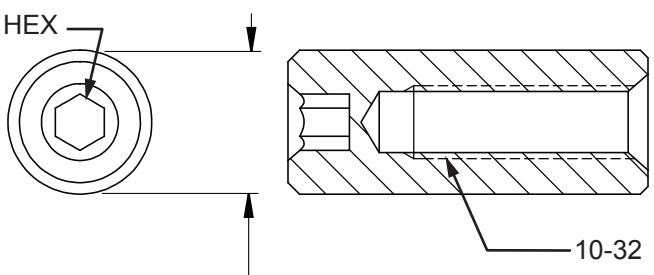

LOGO: 72 TELE THINLINE
APPLIED UNDER THE FINISH



TV JONES CLASSIC PICKUP SPECIFICATIONS		
POSITION	DC RESISTANCE	POLARITY
NECK	4.0KΩ	NORTH SOUTH
BRIDGE	4.8KΩ	NORTH SOUTH