

AMERICAN PROFESSIONAL II STRATOCASTER® HSS (011390XXXX)

PARTS LAYOUT

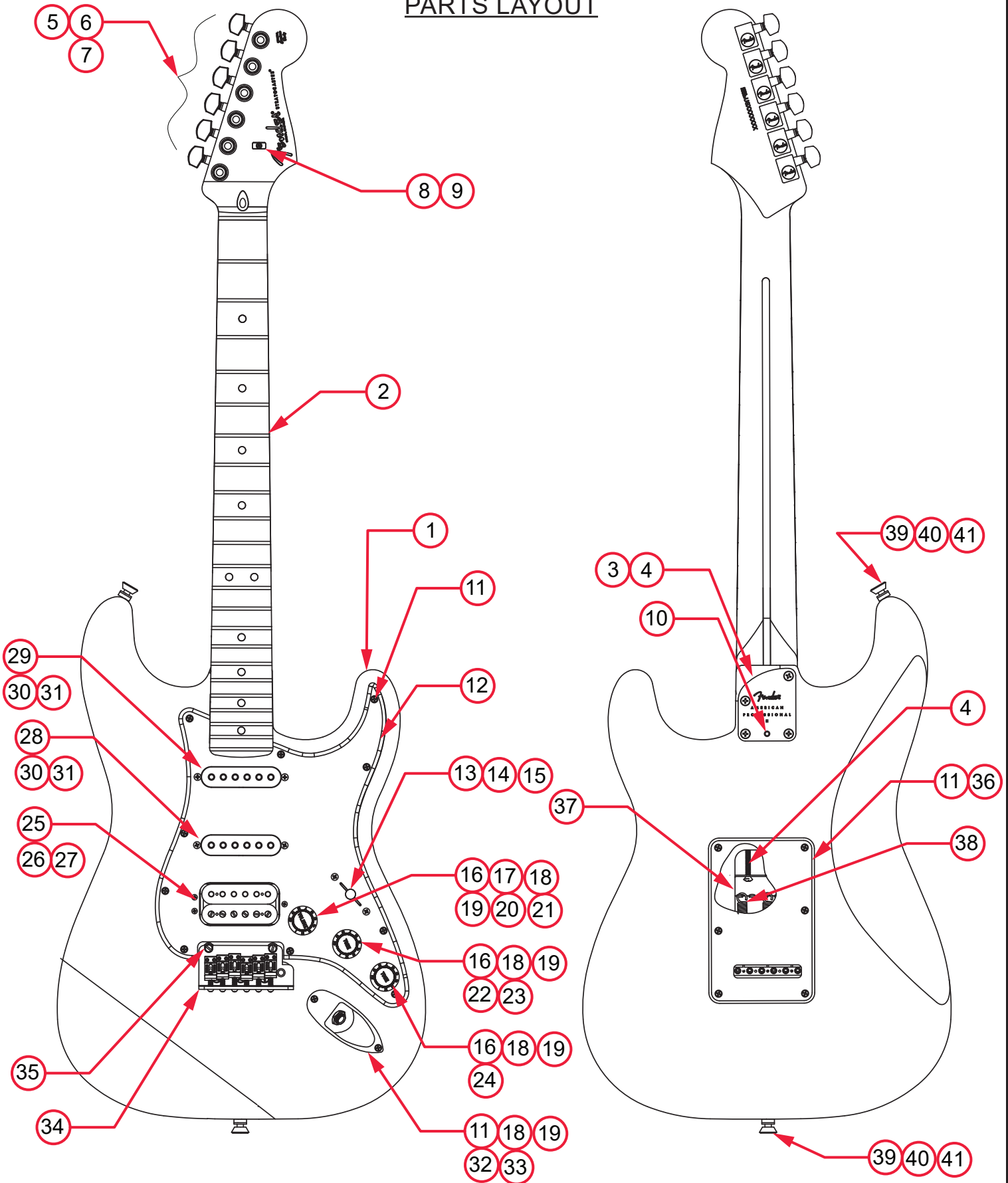

AMERICAN PROFESSIONAL II STRATOCASTER® HSS (011390XXXX)

PARTS LIST

REF#	DESCRIPTION	PART NUMBER
1	BODY AM PRO II STRAT 3TSB	7719096500
1	BODY AM PRO II STRAT OWT	7719190505
1	BODY AM PRO II STRAT DK NIT	7719190561
1	BODY AM PRO II STRAT MBL	7719190519
1	BODY AM PRO II STRAT RST PINE	7719779563
1	BODY AM PRO II STRAT MYST SFG	7719190518
1	BODY AM PRO II STRAT MERC	7719190555
1	BODY AM PRO II STRAT BLK	7719190506
1	BODY AM PRO II STRAT SSB	7719779547
2	NECK ASSY AM PRO II STRAT RW	7718080000
2	NECK ASSY AM PRO II STRAT MPL	7718081000
3	NECK PLATE AM PRO II W/TILT CHROME	7718160000
4	SCREWS SMA 8 X 1-3/4 OHP NI	0015636049
5	KEY GTR DUAL PIN MTG (2) LONG (4) SHORT W/HDWR	0990820100
6	WASHERS KEY (6)	0053106049
7	BUSHINGS KEY (6)	0058820049
8	STRING TREE AM ELITE GTR SERIES	7708381000
9	SCREW SMA 2X9-16 FHP NI	0051621000
10	SET SCREW 1/4-20x3/8 OP NI HEX	0031571049
11	SCREW SMAB 4x1/2 OHP NI	0015578049
12	PICKGUARD AM STD STRAT 1HB BROWN SHELL	0054022000
12	PICKGUARD AM STD STRAT 1HB AW/B/AW	7716392000
12	PICKGUARD AM STD STRAT 1HB B/W/B	0055267000
12	PICKGUARD AM STD STRAT 1HB MG/BLK/MG	0054021000
13	SWITCH 5-WAY LEVER DISCRETE/COM	0078776049
14	SCREW MACH 6-32 X 5/8 RH NI	0994925000
15	KNOB LEVER SWITCH AGD WHT	0994938000
15	KNOB LEVER SWITCH BLACK	0994939000
16	KNOBS STRAT (1) VOL (2) TONE AGED WHT	0991369000
16	KNOBS STRAT (1) VOL (2) TONE BLK	0991365000
17	CONTROL DUAL 500K/250K 3/8 BUSH SPLIT	7707211000
18	WASHER LOCK INTL 3/8 X .687	0016436049
19	NUT HEX 3/8-32x3/32 TK NI	0016352049
20	PCB ASSY TREB BLEED AM PRO STRAT/TELE	7711092000
21	PCB ASSY TREB BLEED AM PRO STRAT SHAW	7711093000

*= NOT PICTURED IN DIAGRAM



AMERICAN PROFESSIONAL II STRATOCASTER® HSS (011390XXXX)

REF#	DESCRIPTION	PART NUMBER
22	CONTROL 250K 10% TPR SPLIT	0990830000
23	CAP MPF RDL .022MF 250V 10%	0024832049
24	POT W/ LATCHING PUSH SWITCH KNURLED SHAFT 500K	7718145000
25	PICKUP AM PRO II STRAT BRG HB ZEBRA	7718228000
25	PICKUP AM PRO II STRAT BRG HB BLK	7720587000
26	SPRING HUMB MTG 3/4"	0050167049
27	SCREW MACH 3-48 x 13/16 NI	0051596049
28	PICKUP AM PRO II STRAT MID AW	7718226000
28	PICKUP AM PRO II STRAT MID BLK	7720583000
29	PICKUP AM PRO II STRAT NK AW	7718225000
29	PICKUP AM PRO II STRAT NK BLK	7720581000
30	SCREW TF 6-32x3/4 RHP STL NI	0099346049
31	TUBING LATEX CUT .300 x 1/8ID x 1/4OD	0994916000
32	FERRULE JACK CHROME	0991940100
33	JACK PHONE OPEN CIRCT 11	0021956049
34	BRIDGE ASSY AM PRO II STRAT RH CHR	7718086000
34A	BRIDGE PLATE TREM AM PRO STRAT RH CHR	7709899000
34B	BRIDGE BLOCK AM PRO II STRAT RH	7718090000
34C	BRIDGE SECTION ASSY NI AS STRAT SHORT	0075123101
34D	BRIDGE SECTION ASSY NI AS STRAT TALL	0075123102
34E	SPRING BRIDGE #1932	0019281049
34F	SCREW M 4-40 X 5/8 RHP NI	0015693049
34G	SCREW M 8-32 X 3/8 FHP NI	0019656049
34H	SPRING CLIP ULTRA	0036531000
34I	BUSHING NYL NAT .31 OD X .191 ID X .87 L	7710005000
35	PIVOT POST ASSEMBLY	0093273000
36	COVER BACK STRAT W/SLOT BROWN SHELL	0049683000
36	COVER BACK STRAT W/SLOT B/W/B	0038492000
36	COVER BACK STRAT W/SLOT MG/BLK/MG	0054029000
36	COVER BACK STRAT W/SLOT AW/B/AW	7716290000
37	CLAW SPRNG TENS. ZINC	0010272149
38	SPRING TREM TENSION BLK OX	0018671049
39	STRAP BUTTONS CHROME W/HARDWARE	0063267049
40	FELT WASHERS WHITE	0994930000
40	FELT WASHER BLACK	0994929000
41	WOOD SCREW 6 X 1 OHP NI	0016188049

*= NOT PICTURED IN DIAGRAM







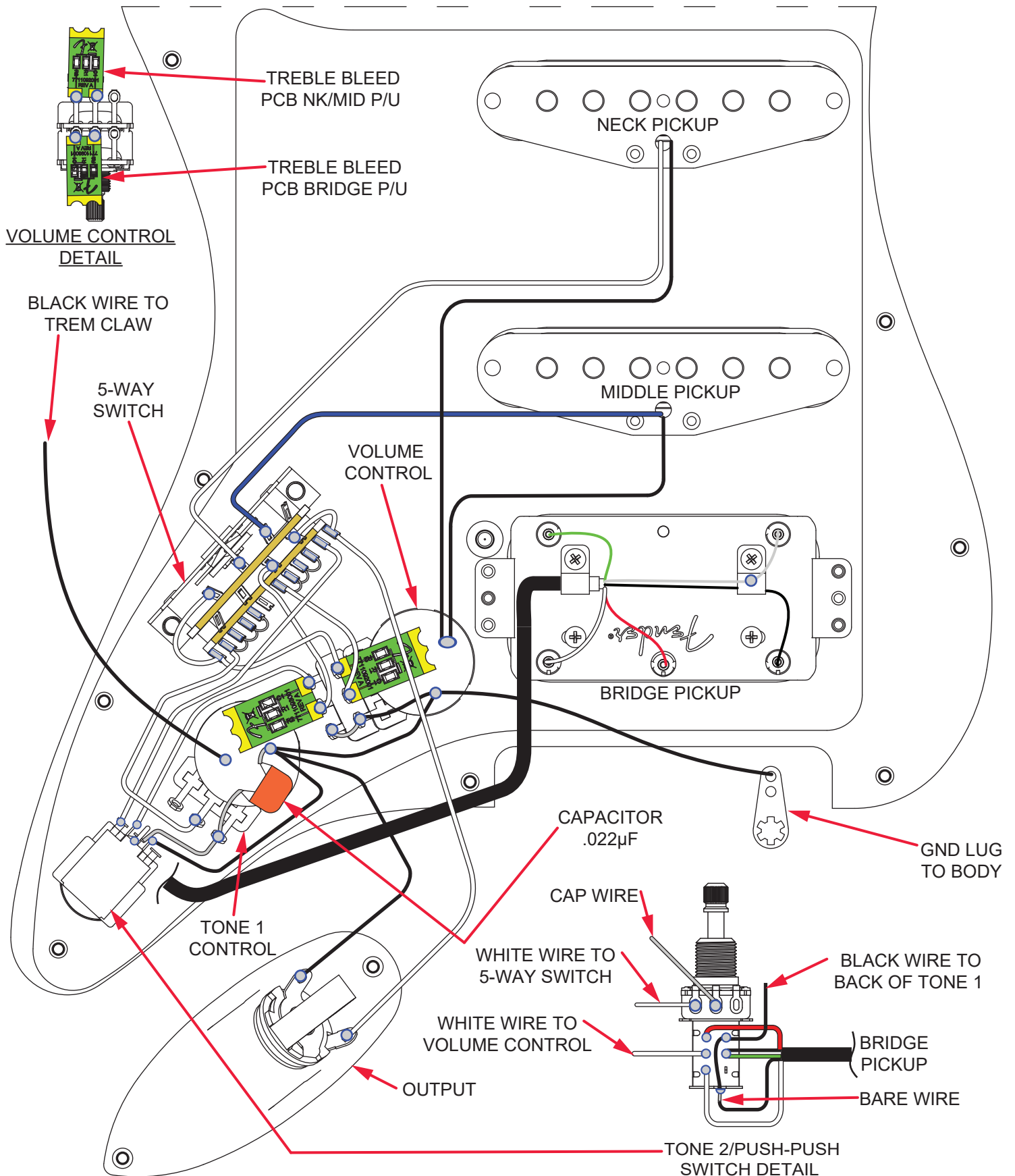





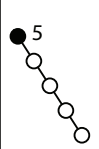
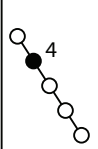
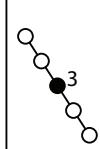

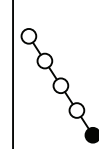

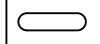





AMERICAN PROFESSIONAL II STRATOCASTER® HSS (011390XXXX)



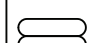







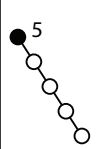
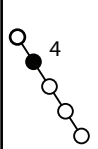
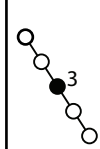

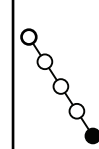





WIRING ASSEMBLY



AMERICAN PROFESSIONAL II STRATOCASTER® HSS (011390XXXX)

SWITCH AND CONTROL FUNCTION

5-WAY SWITCH POSITION					 PUSH-PUSH (DOWN POSITION) COMBINED PICKUPS ARE IN PARALLEL
					
T1	T1	T1	T1	T2	CONTROL
					← NECK PICKUP
					← MIDDLE PICKUP
					← BRIDGE PICKUP
	PICKUP IS OFF				 INDICATES POSITION OF 5 WAY SWITCH
	PICKUP IS ON				

5-WAY SWITCH POSITION					 PUSH-PUSH (UP POSITION) COMBINED PICKUPS ARE IN PARALLEL
					
T1	T1	T1	T1	T2	CONTROL
					← NECK PICKUP
					← MIDDLE PICKUP
					← BRIDGE PICKUP

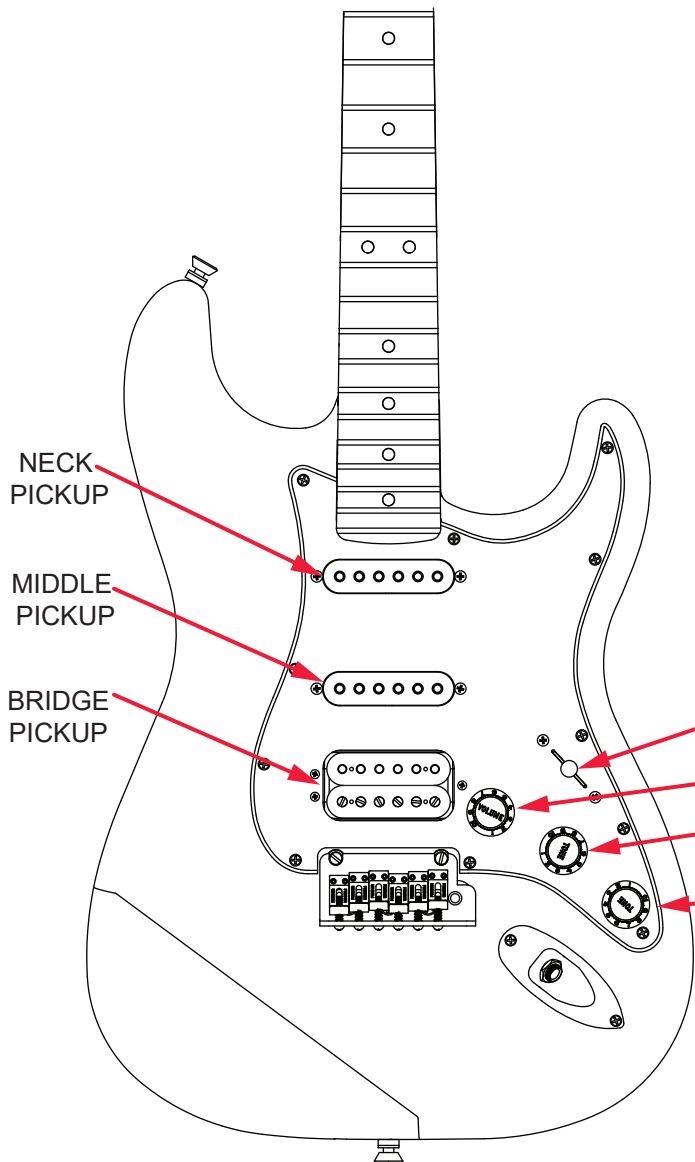

5-WAY SWITCH

MASTER VOLUME

TONE 1 (T1)

TONE 2/PUSH-PUSH SWITCH (T2)



AMERICAN PROFESSIONAL II STRATOCASTER® HSS (011390XXXX)

ADDITIONAL SPECIFICATION DETAIL

FRET SIZE: JUMBO NARROW
(FRET DIMENSIONS ARE BEFORE INSTALLATION)

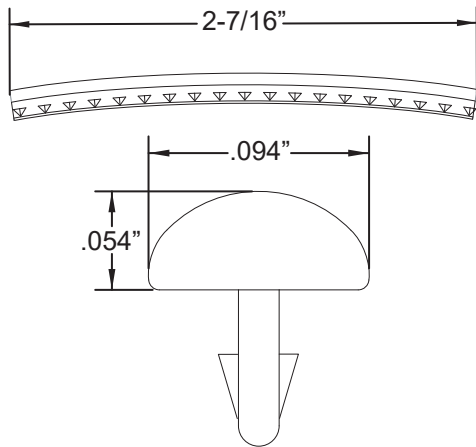

PLEASE NOTE: AS EACH NECK IS SANDED & FINISHED BY HAND, THICKNESS DIMENSIONS MAY VARY SLIGHTLY FROM THOSE SHOWN.

NECK PROFILE: MODERN DEEP "C"

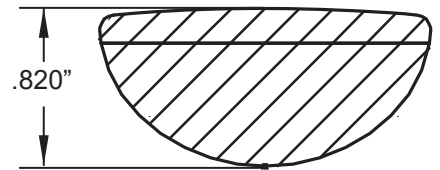

1ST FRET PROFILE

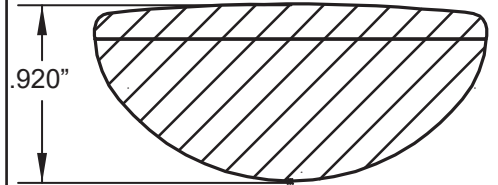

12TH FRET PROFILE

TUNING MACHINE SET W/HDWR (2) LONG (4) SHORT P/N 0990820100
OUTER SHAFT DIAMETER .394"

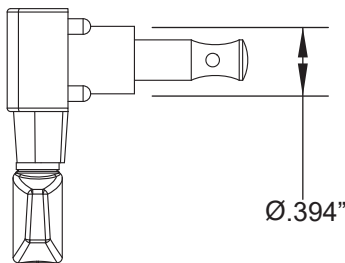

TUNING MACHINE THRU-HOLE
INNER DIAMETER .404"

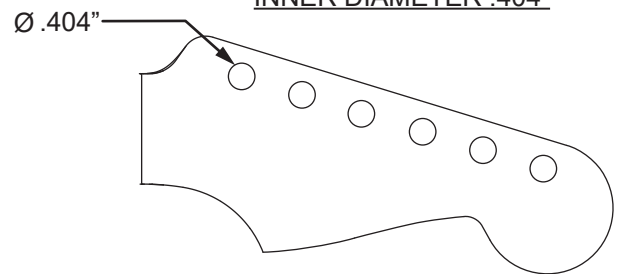

SADDLE HEIGHT ADJUSTMENT WRENCH:
.050" HEX KEY P/N 0018531049

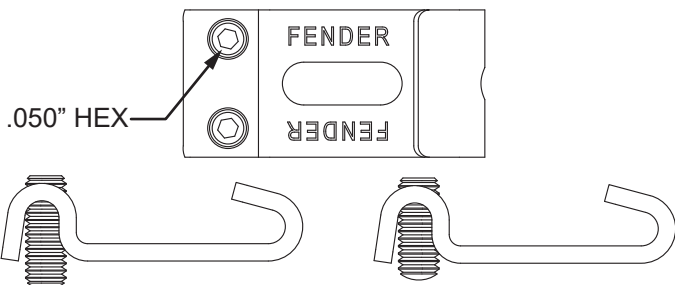

SADDLE HEIGHT ADJUSTMENT SCREWS:
TALL: P/N 0075384000 SHORT: P/N 0075536000

TRUSS ROD NUT P/N 0994943000
TRUSS ROD ADJUSTMENT WRENCH:
1/8" HEX KEY P/N 0023811049

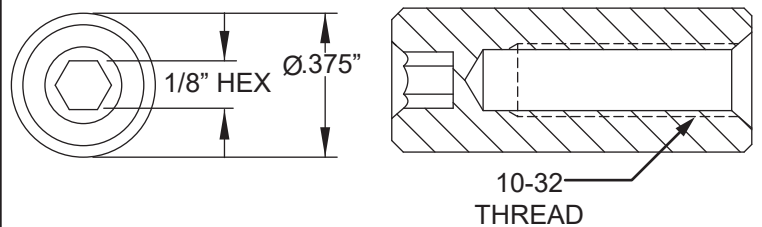

LOGO: AMERICAN PRO STRAT
APPLIED UNDER THE FINISH



PICKUP SPECIFICATIONS

POSITION	MAGNETS	DC RESISTANCE	POLARITY
NECK	ALNICO 2 & 3 BEVELED	5.75 - 6.35KΩ	SOUTH
MIDDLE	ALNICO 5 & 2 BEVELED	5.9 - 6.5KΩ	NORTH
BRIDGE	ALNICO 5 BAR	6.08 - 6.68KΩ HUMBUCKER 3.6 - 4.2KΩ SINGLE COIL	NORTH SOUTH

