

AMERICAN PROFESSIONAL II JAZZMASTER® (01397XXXX)

PARTS LAYOUT

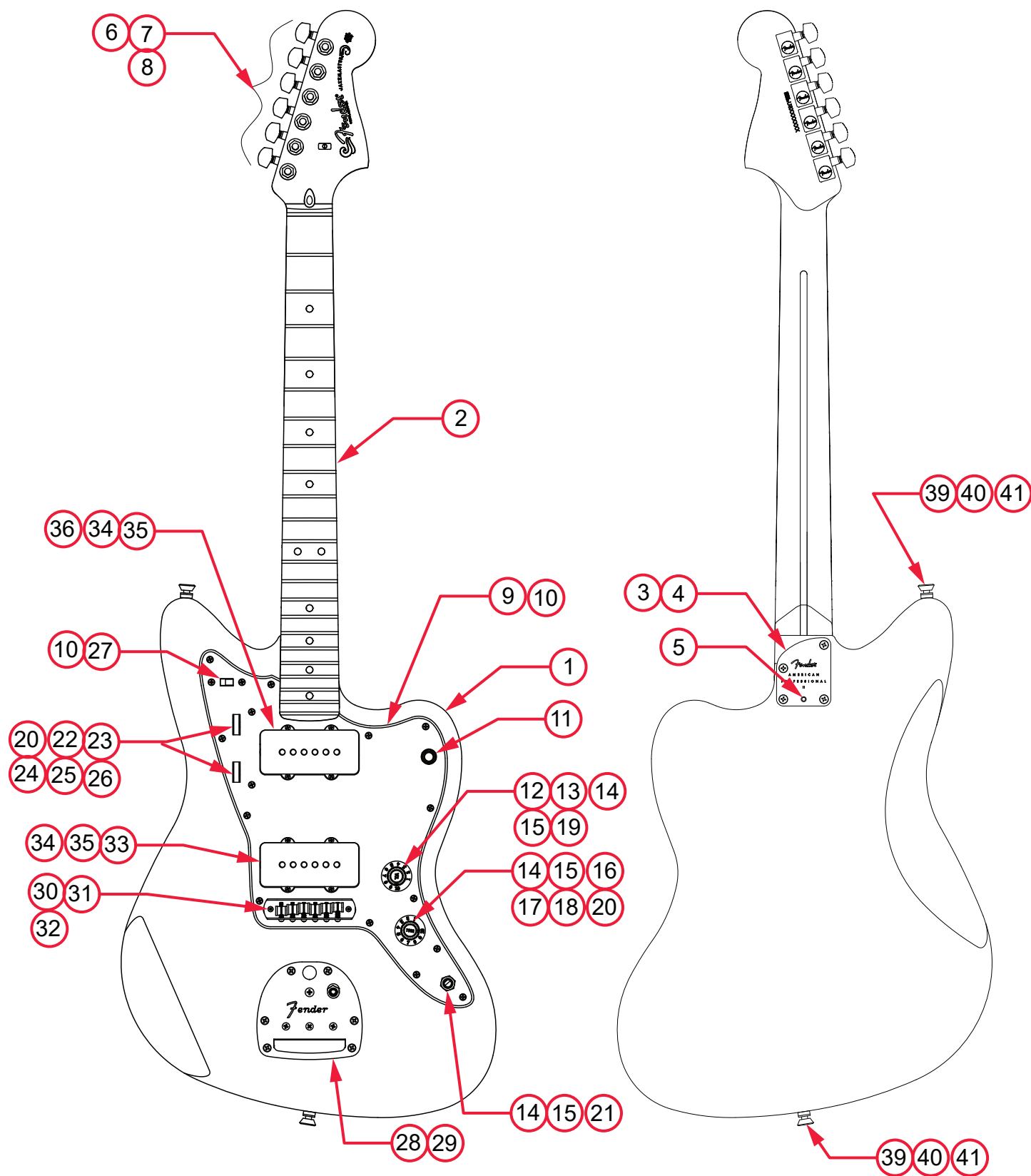

AMERICAN PROFESSIONAL II JAZZMASTER® (01397XXXX)

PARTS LIST

REF#	DESCRIPTION	PART NUMBER
1	BODY AM PRO II JAZZMASTER 3TSB	7718286500
1	BODY AM PRO II JAZZMASTER DK NIT	7718287561
1	BODY AM PRO II JAZZMASTER MERC	7718287555
1	BODY AM PRO II JAZZMASTER MYST SFG	7718287518
1	BODY AM PRO II JAZZMASTER MBL	7718287519
2	NECK ASSY AM PRO II JAZZMASTER RW	7718289000
2	NECK ASSY AM PRO II JAZZMASTER MPL	7718290000
3	PLATE NECK AM PRO II TILT CHRМ	7718160000
4	SCREW SMA 8 X 1-3/4 OHP NI	0015636049
5	SET SCREW 1/4-20x3/8 OP NI HEX	0031571049
6	KEY GTR DUAL PIN MTG SET (2) LONG (4) SHORT W/HDWR	0990820100
7	WASHER KEY (6)	0053106049
8	BUSHING KEY (6)	0058820049
9	PICKGUARD JAZZMASTER BRN SHELL	0094459000
9	PICKGUARD JAZZMASTER RED SHELL/P/B/P	7719273000
9	PICKGUARD JAZZMASTER B/W/B	7719274000
9	PICKGUARD JAZZMASTER MG/B/MG	0054451000
10	SCREW SMAB 4 X 1/2 OHP NI	0015578049
11	TOGGLE SWITCH 3-POS BLK W/HDWR	0078433000
12	KNOB VOLUME 72 TELE CUSTOM	0054521049
13	CONTROL 500K A.TAPER .25 X .625 S-SHAFT	0079409000
14	NUT HEX 3/8-32 X 3/32 TK NI	0016352049
15	WASHER INT LOCK .035 X 3/8 NI	0056790000
16	KNOB TONE 72 TELE CUST	0054521049
17	POT W/ LATCHING PUSH SWITCH PLAIN SHAFT 500KA	7717082000
18	SPACER NYLON .250OD X .09ID X .125L	7720927000
19	PCB ASSY TREB BLEED AM PRO JAG/JAZZ	7711095000
20	CAP MPF RDL .022MF 250V 10%	0024832049
21	JACK PHONE OPEN CIRCT 11	0021956049
22	BRACKET CONTROL MTG JAZZMASTER W/HDWR	0054454049
23	SCREW M 4-40x1/4 OHP NI	0015719049
24	CTRL MINIPOT 1-MEG LIN W/HDWR	0054457049
25	KNOB DISC PRESET CNTRL 1"x.25	0054455049
26	WASHER LOCK INTERNAL TOOTH 1/4	0016451000
27	SWITCH SLIDE 4PDT TAPPED	7717684000

*= NOT PICTURED IN DIAGRAM



AMERICAN PROFESSIONAL II JAZZMASTER® (01397XXXX)

REF#	DESCRIPTION	PART NUMBER
28	TREMOLO ASSY AM PRO II JAGUAR / JAZZMASTER	7719000000
28A	BASE PLATE TREMOLO JAGUAR / JAZZMASTER POP IN	7715654000
28B	PLATE TAIL PC. STIFFENER JAZZMASTER POP IN	7715923000
28C	BLOCK LOCKING TREM JAZZMASTER POP IN	7715924001
28D	JAG/JAZZ TREM HINGE CENTER	7718539000
28E	JAG/JAZZ TREM HINGE OUTSIDE	7718540000
28F	SLEEVE TREMOLO LEVER JAZZMASTER POP IN	7715653000
28G	M2 TOOL STEEL DRILL ROD .113X2.2625	7718998000
28H	SHOULDER WASHER NYLON 6-6	7718999000
28I	SCRW M 8-32x1-1/4 PHP NI	0015966000
28J	SPRING TREMOLO ACTION .080 X 6 COIL	0019307000
28K	PERCH SPRING JAGUAR / JAZZMASTER TREMOLO	0024992000
28L	SCREW M 8-32 X 1/4 UHFP NI	0015883049
28M	SPRING CLIP ULTRA	0036531000
28N	SET SCREW HEX OV PT 10-32 X 1/2	0020972049
28O	LOCK NUT TREMOLO JAGUAR/JAZZMASTER	0054475000
28P	LOCK BUTTON TREMOLO JAGUAR/JAZZMASTER	0054474000
28Q	WAVE WASHER STYLE #6 .385 OD X .170 ID	0054476000
28R	SCREW MACH 10-32 X 3/8 THP BLX	0015364000
28S	SCREW MACH 4-40 X 5/16 HEX SKT BLX	0076985000
28T	SCREW MACH 6-32 X 1/4 PHP NI ITLW	0023175000
28U	BUSHING NYLON NAT .31 OD X .219 ID X 1.35L	7715945000
28V	PLATE TREM FLOAT TAIL PC JAZZMASTER POP IN	7715922000
29	SCREW SMAB 5 X 1 OHP NI	0015610049
30	BRIDGE ASSY AM PRO JAGUAR / JAZZMASTER	7709942000
30a	CHANNEL AND POST BRIDGE PLATE JAGUAR / JAZZMASTER	0054519000
30B	SCREW ST 4-40 X 1/2 OC CN PT	0056157049
30C	SCREW M 4-40 X 5/8 RHP NI	0015693049
30D	SPRING INTONATION ADJ 7 COIL	0056139000
30E	SADDLE E-E AM PRO JAG/JAZZ BRASS NI	7709941010
30F	SADDLE D-G DYNAMIC VIBRATO BRIDGE BRASS NI	0091085010
30G	SADDLE A-B DYNAMIC VIBRATO BRIDGE BRASS NI	0091086010
31	THIMBLE BRIDGE POST JAG/JAZZ	0054447049
32	SLEVE THIMBLE AM PRO JAG/JAZZ	7710508000

*= NOT PICTURED IN DIAGRAM



AMERICAN PROFESSIONAL II JAZZMASTER® (01397XXXX)

WIRING ASSEMBLY

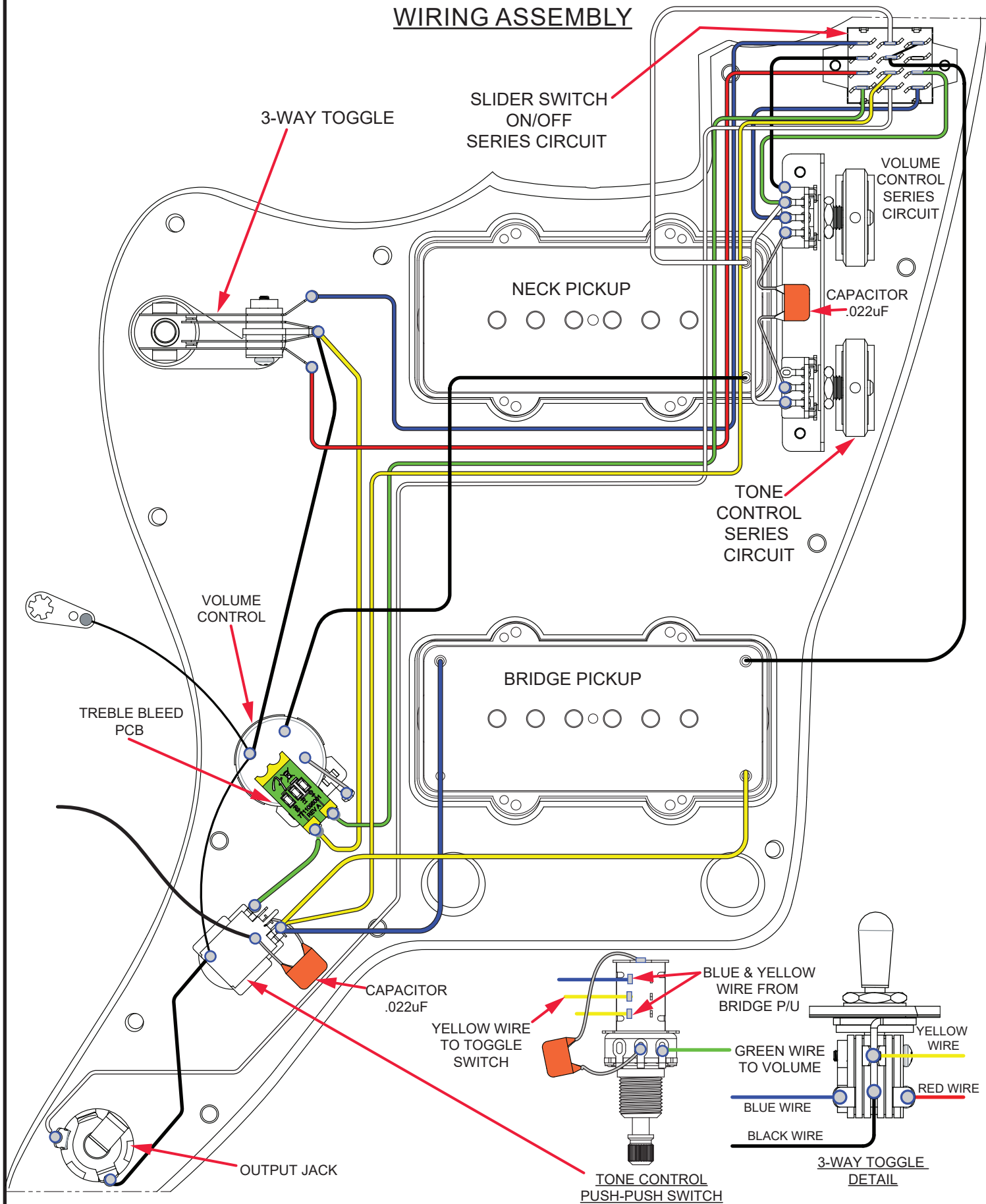







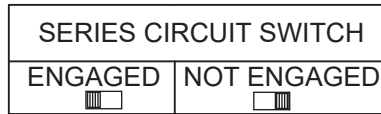

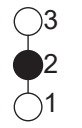
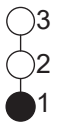
AMERICAN PROFESSIONAL II JAZZMASTER® (01397XXXX)

SWITCH AND CONTROL FUNCTION

NOTE: WHEN SERIES CIRCUIT IS ENGAGED, BRIDGE AND NECK PICKUPS ARE COMBINED



3-WAY SWITCH FUNCTION (WHEN SERIES CIRCUIT IS ENGAGED MASTER VOLUME, MASTER TONE & 3-WAY SWITCH ARE NON-FUNCTIONAL)			
			POSITION OF 3-WAY SWITCH
			NECK PICKUP
			BRIDGE PICKUP
			PICKUP IS ON PICKUP IS OFF

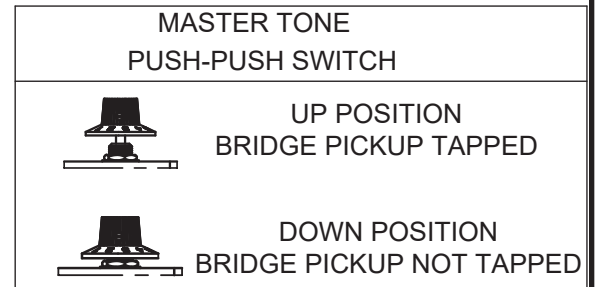
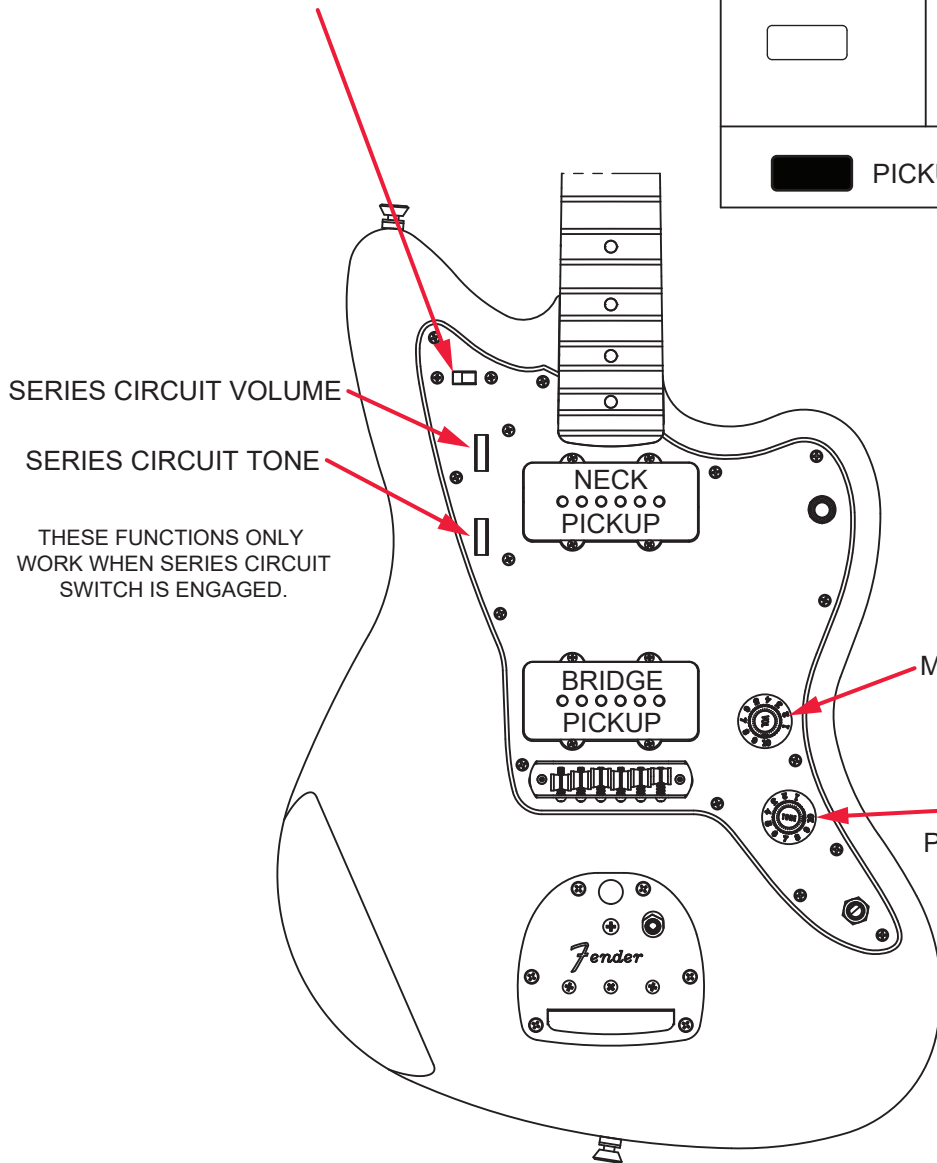

THESE FUNCTIONS ONLY WORK WHEN SERIES CIRCUIT SWITCH IS ENGAGED.

AMERICAN PROFESSIONAL II JAZZMASTER® (01397XXXX)

ADDITIONAL SPECIFICATION DETAIL

FRET SIZE: JUMNBO NARROW
(FRET DIMENSIONS ARE BEFORE INSTALLATION)

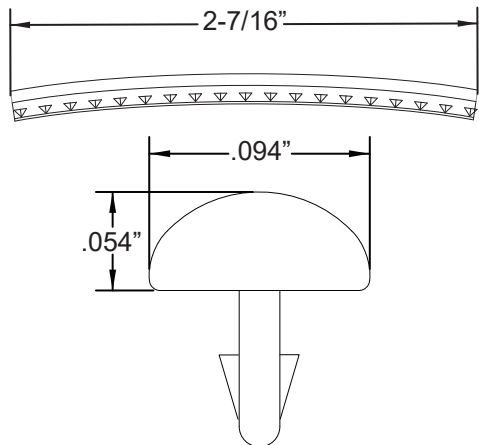

PLEASE NOTE: AS EACH NECK IS SANDED & FINISHED BY HAND, THICKNESS DIMENSIONS MAY VARY SLIGHTLY FROM THOSE SHOWN.

NECK PROFILE: MODERN DEEP "C"

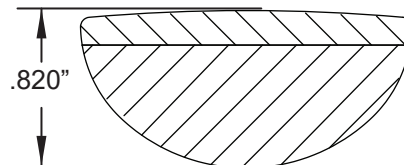

1ST FRET PROFILE

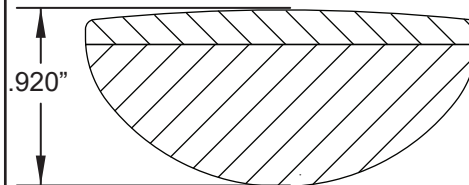

12TH FRET PROFILE

STAGGERED TUNING MACHINE SET W/HDWR P/N 0990820100
OUTER SHAFT DIAMETER .394"

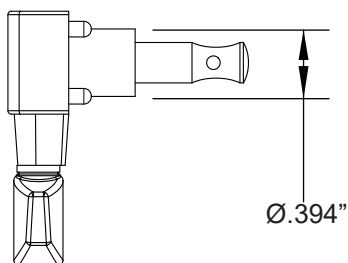

TUNING MACHINE THRU-HOLE
INNER DIAMETER .404"

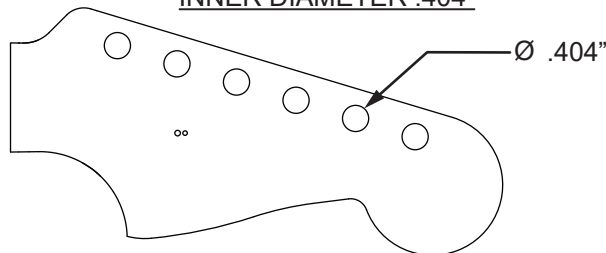

BRIDGE HEIGHT ADJUSTMENT WRENCH:
.050" HEX KEY P/N 0018531049

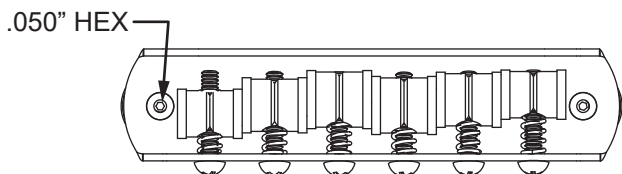

TRUSS ROD NUT P/N 0994943000
TRUSS ROD ADJUSTMENT WRENCH:
1/8" HEX KEY P/N 0023811049

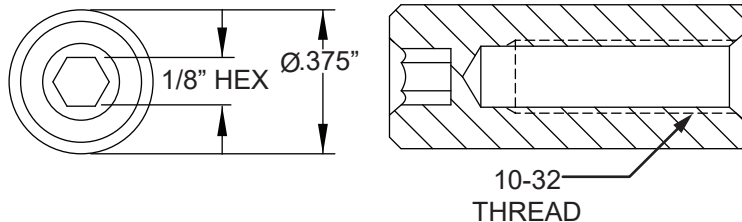

LOGO: AMERICAN PRO JAZZMASTER
APPLIED UNDER FINISH



PICKUP SPECIFICATIONS

POSITION	MAGNETS	DC RESISTANCE	POLARITY
NECK	ALNICO 4 UNBEVELED	7.0 - 7.6KΩ	NORTH
BRIDGE	ALNICO 4 UNBEVELED	11.0 - 11.6KΩ	SOUTH