

AMERICAN ULTRA LUXE TELECASTER® (011808XXXX)

PARTS LAYOUT

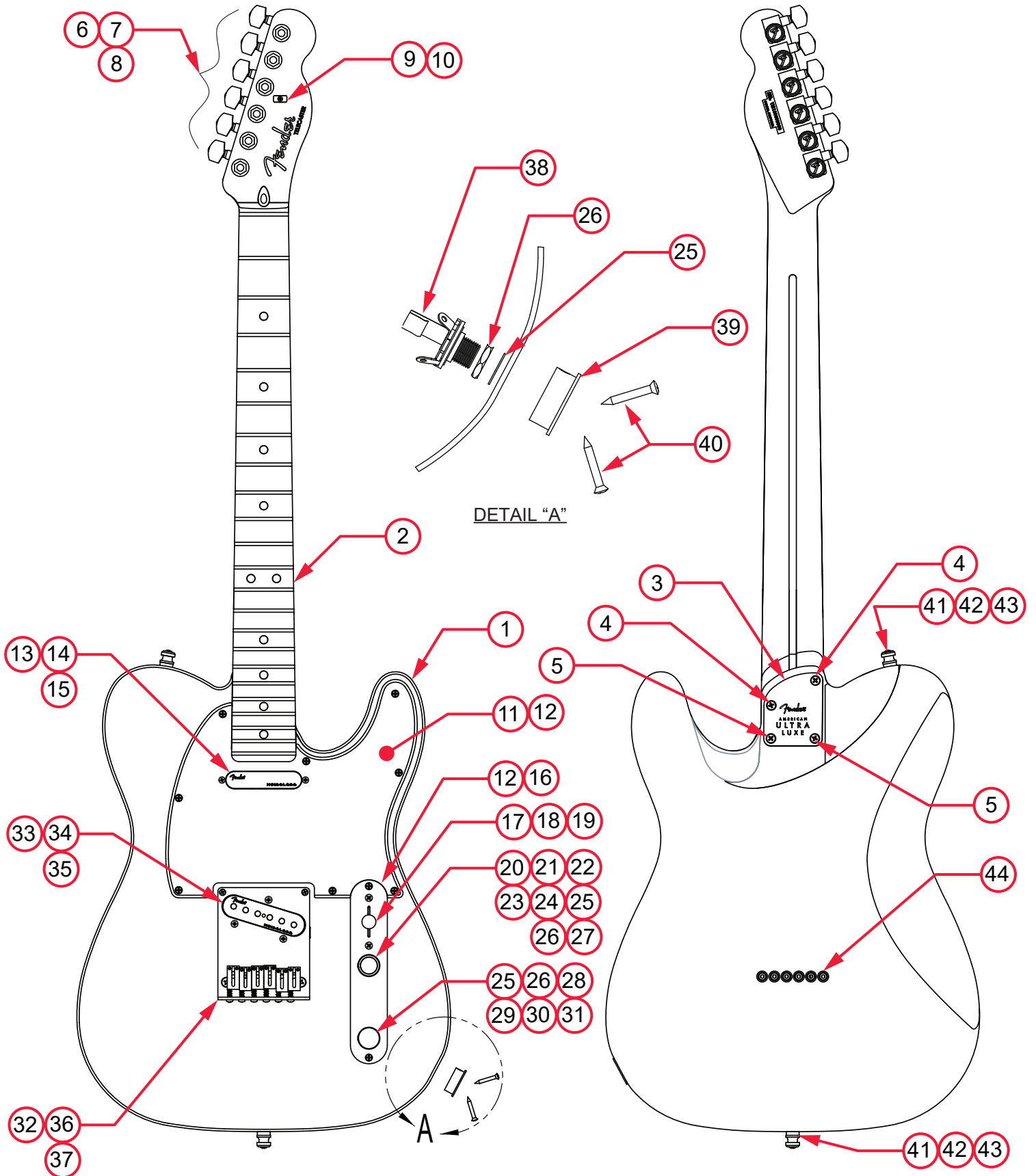

AMERICAN ULTRA LUXE TELECASTER® (011808XXXX)

PARTS LIST

REF#	DESCRIPTION	PART NUMBER
1	BODY AM ULTRA TELE 2TSB	7715740503
1	BODY AM ULTRA TELE SFG TRN	7715741535
2	NECK ASSY AM ULTRA LUXE TELE SS MATCHING HDCP RW	7718806000
2	NECK ASSY AM ULTRA LUXE TELE SS SALEM HDCP MPL	7719030000
3	NECK PLATE GUITAR AM ULTRA LUXE CHROME	7720961000
4	SCREW SMA 8 X 1-1/4 OHP NI	0072900000
5	SCREW SMA 8 X 1-1/2 OHP STL NI	7716272000
6	KEY LOCK "F" SHORT CHROME	0073114049
7	WASHERS KEY (6)	0053106049
8	BUSHINGS KEY (6)	0058820049
9	STRING TREE AM ELITE GTR CHROME	7708381000
10	SCREW SMA 2 X 9/16	0051621000
11	PICKGUARD AM STD TELE AGW/BLK/AGW	7716789000
11	PICKGUARD AM STD TELE RED TORT	7719175000
12	SCREW SMAB 4 X 1/2 OHP NI	0015578049
13	PICKUP ASSY TELE N4 NECK VINT	7715762000
14	TUBING SIL RUB CUT RED .688	7709812000
15	SCREW MACH 4-40 X 7/8 RHP NI	7700222000
16	CONTROL PLATE TELE VINT ALUM CHR	0093823000
17	KNOB SWITCH VINT TELE	0994936000
18	SWITCH 3-WAY LEVER	0992041000
19	SCREW MACH 6-32 X 5/8 RHP NI	0994925000
20	SW KNOB TELE/P-BASS ALUM W/SCREW CHR	0097217000
21	SW CAP TELE/P-BASS CHRM	0059270000
22	SW/POT ASSY S-1 250K .25B SOSH BT	0078979049
23	COUPLING SLEEVE SOSH NYLN	0059278049
24	PCB ASSY TREBLE BLEED AM PRO STRAT/TELE	7711092000

*= NOT PICTURED IN DIAGRAM



AMERICAN ULTRA LUXE TELECASTER® (011808XXXX)

REF#	DESCRIPTION	PART NUMBER
25	WASHER LOCK INTL 3/8 X .687	0016436049
26	NUT HEX 3/8-32 X 3/32 TK NI	0016352049
27	3-PIN MALE LOCKING QUICK CONNECT WGB 4"	7717595000
28	KNOB CONTROL ALUM CHRМ	0095799049
29	CNTRL 250K 10% TAPER NO-LOAD SOSH B-TECH	0078782000
30	CAP MPF RDL .022MF 250V 10%	0024832049
31	3-PIN MALE LOCKING QUICK CONNECT RGB 4"	7717593000
32	BRIDGE ASSY AM ULTRA TELE W/PICKUP	7715766000
32A	BRIDGE PLATE AM DLX TELE CHROME	0077094000
32B	SADDLE TELE BRSS/CHRM RH CS	0058083000
32C	SCREW MACH 4-40 X 5/8 PHP BLX	0017031049
32D	SPRING INTONATION .115 X 1/2 BLK	0029094049
32E	SCREW MACH 4-40 X 3/4 PHP BLX	0031913049
32F	SPRING INTONATION .115 X 5/8 BLK	0029095049
32G	SCREW HEIGHT ADJ 4-40 X 3/8	0018027049
32H	SCREW HEIGHT ADJ 4-40 X 5/16	0026780049
33	PICKUP ASSY TELE N4 BRIDGE VINT	7715760000
34	SCREW SPECIAL MACH 4-40 X 13/16 #5 HEAD NI	0099474000
35	TUBING SIL RUB CUT RED .688	7709812000
36	SCREW SMA 8 X 1 OHP NI	0021373049
37	SCREW SMA 3 X 1/2 OHP NI	0027956049
38	JACK PHONE OPEN CIRCUIT 11	0021956049
39	JACK PLATE CHROME C/S	0076007000
40	SCREW WOOD #4 X 3/4 OHP	0056156000
41	STRAP BUTTONS ELITE/STD CHROME W/HDWR	0994914000
42	SCREW SMAB 5 X 1 OHP NI	0015610049
43	FELT WASHERS WHITE	0994930000
43	FELT WASHER BLACK	0994929000
44	FERRULES STRING RETAINER NI (6)	0994918000
*	CASE MOLDED AM ELITE GTR	7708545000
*	WRENCH .050 HEX KEY (SADDLE HEIGHT ADJUSTMENT)	0018531049
*	WRENCH 1/8 HEX KEY (TRUSS ROD ADJUSTMENT)	7715532000

*= NOT PICTURED IN DIAGRAM



AMERICAN ULTRA LUXE TELECASTER® (011808XXXX)

WIRING ASSEMBLY

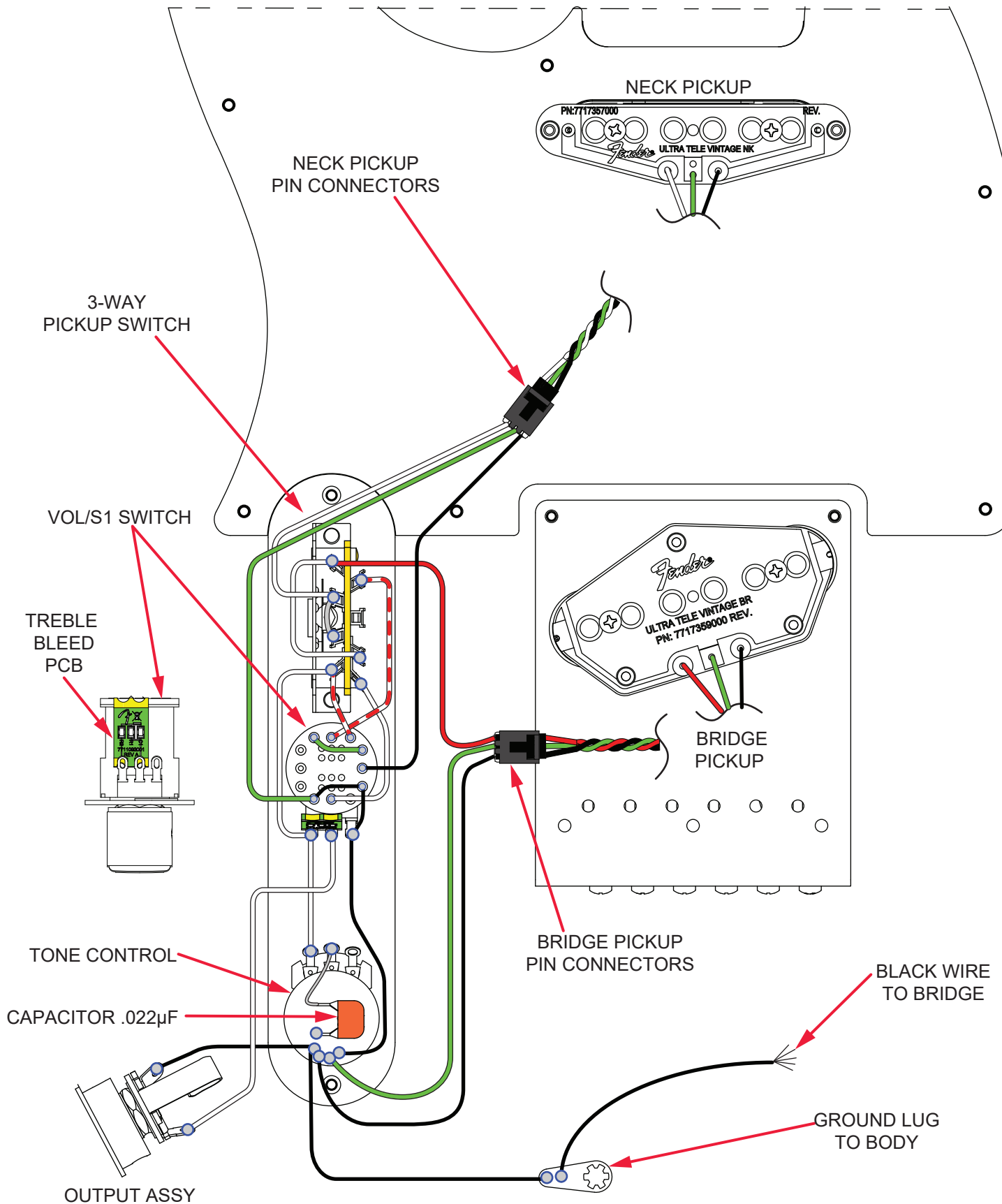

AMERICAN ULTRA LUXE TELECASTER® (011808XXXX)

SWITCH AND CONTROL FUNCTION

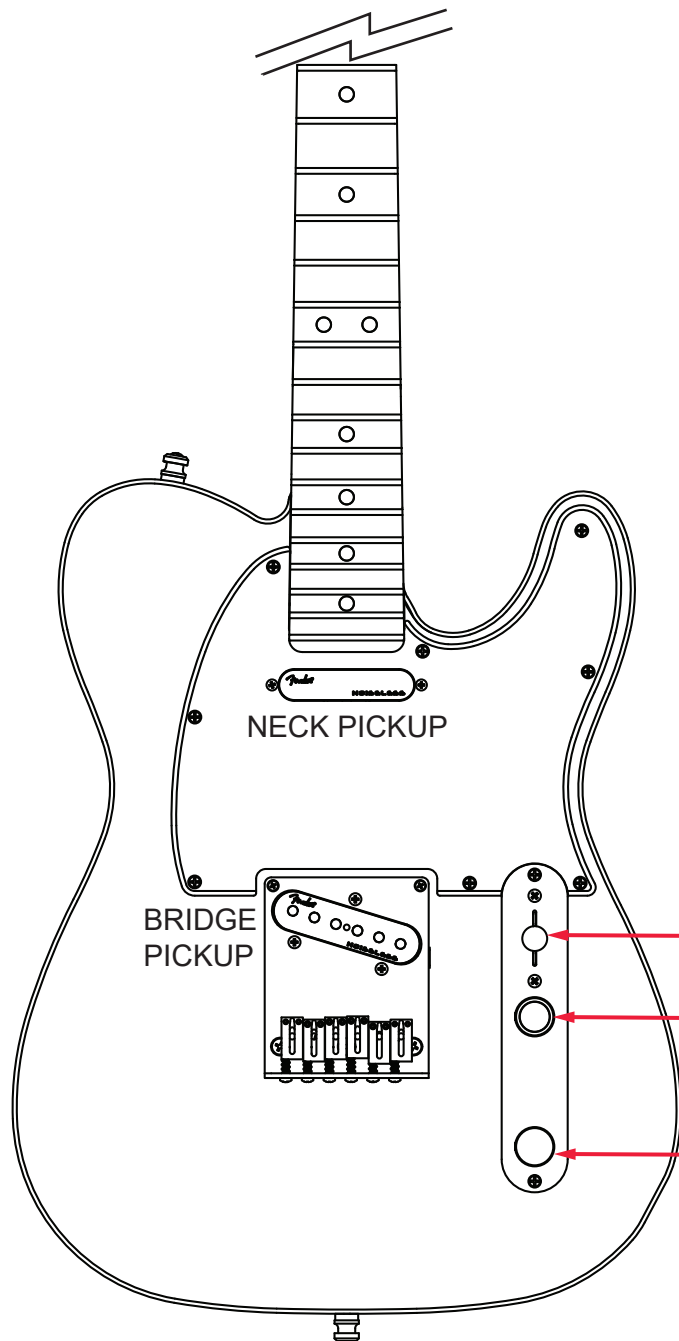

3 WAY SWITCH POSITIONS			
			← 3 WAY SWITCH POSITION
			← NECK PICKUP
<hr/>			
			← BRIDGE PICKUP
3 WAY & S1 SWITCH POSITIONS			
	S1 SWITCH FUNCTIONS WORK IN #2 POSITION OF 3 WAY SWITCH <u>ONLY</u>		
			← OFF - UP POSITION - S1 SWITCH CONNECTS PICKUPS PARALLEL
			← ON - DOWN POSITION - S1 SWITCH CONNECTS PICKUPS IN SERIES
	PICKUP IS ON		← INDICATES 3 WAY SWITCH POSITION
	PICKUP IS OFF		

AMERICAN ULTRA LUXE TELECASTER® (011808XXXX)

ADDITIONAL SPECIFICATION DETAIL

FRET SIZE: MEDIUM JUMBO S/S
(FRET DIMENSIONS ARE BEFORE INSTALLATION)

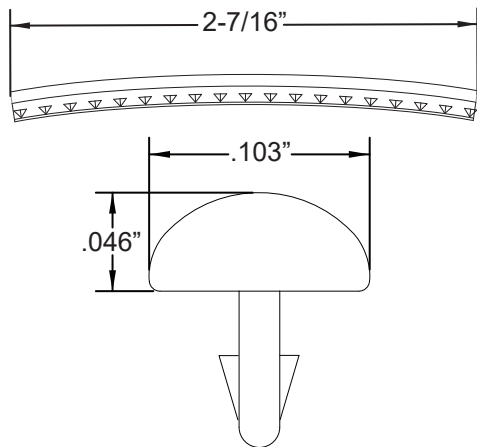

PLEASE NOTE: AS EACH NECK IS SANDED & FINISHED BY HAND, THICKNESS DIMENSIONS MAY VARY SLIGHTLY FROM THOSE SHOWN.

NECK PROFILE: AUGMENTED "D"

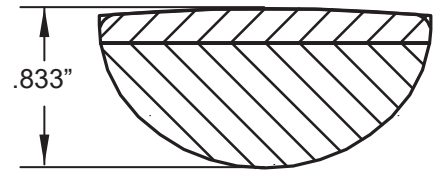

1ST FRET PROFILE

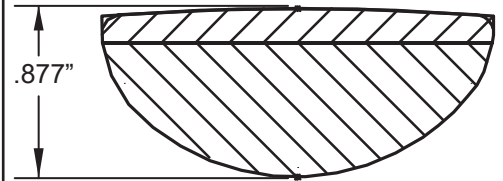

12TH FRET PROFILE

TUNING KEY LOCKING "F" SHORT CHROME P/N 0073114049
OUTER SHAFT DIAMETER .394"

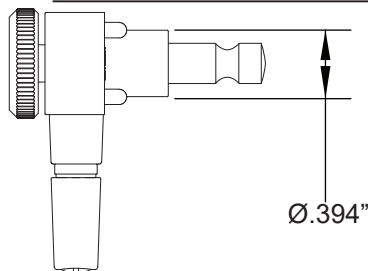

TUNING MACHINE THRU-HOLE
INNER DIAMETER .404"

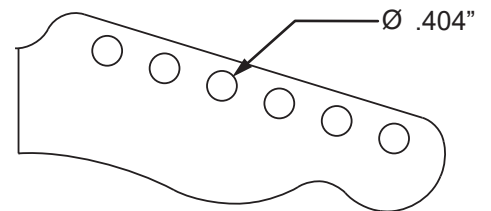

SADDLE HEIGHT ADJUSTMENT WRENCH:
.050" HEX KEY P/N 0018531049

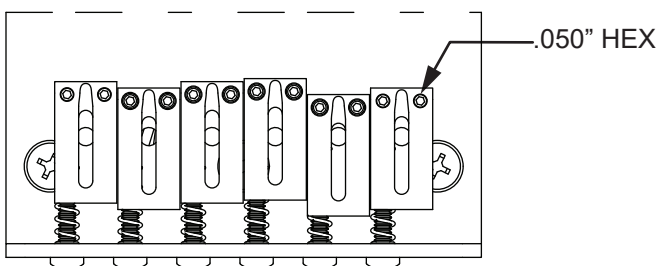

SADDLE HEIGHT SET SCREWS

3/8": P/N 0018027049

5/16": P/N 0026780049

TRUSS ROD NUT P/N 0994943000
TRUSS ROD ADJUSTMENT WRENCH:
1/8" HEX KEY P/N 7715532000

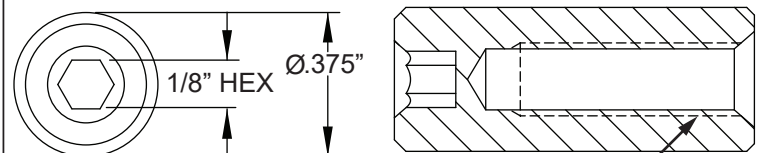

10-32
THREAD

LOGO: AMERICAN ULTRA TELE GOLD CHROME
APPLIED UNDER THE FINISH



PICKUP SPECIFICATIONS

POSITION	MAGNETS	DC RESISTANCE	POLARITY
NECK	ALNICO 5 UNBEVELED	11.3 - 11.7KΩ	NORTH
BRIDGE	ALNICO 5 UNBEVELED	9.9 - 10.5KΩ	NORTH