

60'S TELE BIGSBY® (014-9883-XXX)

PARTS LAYOUT

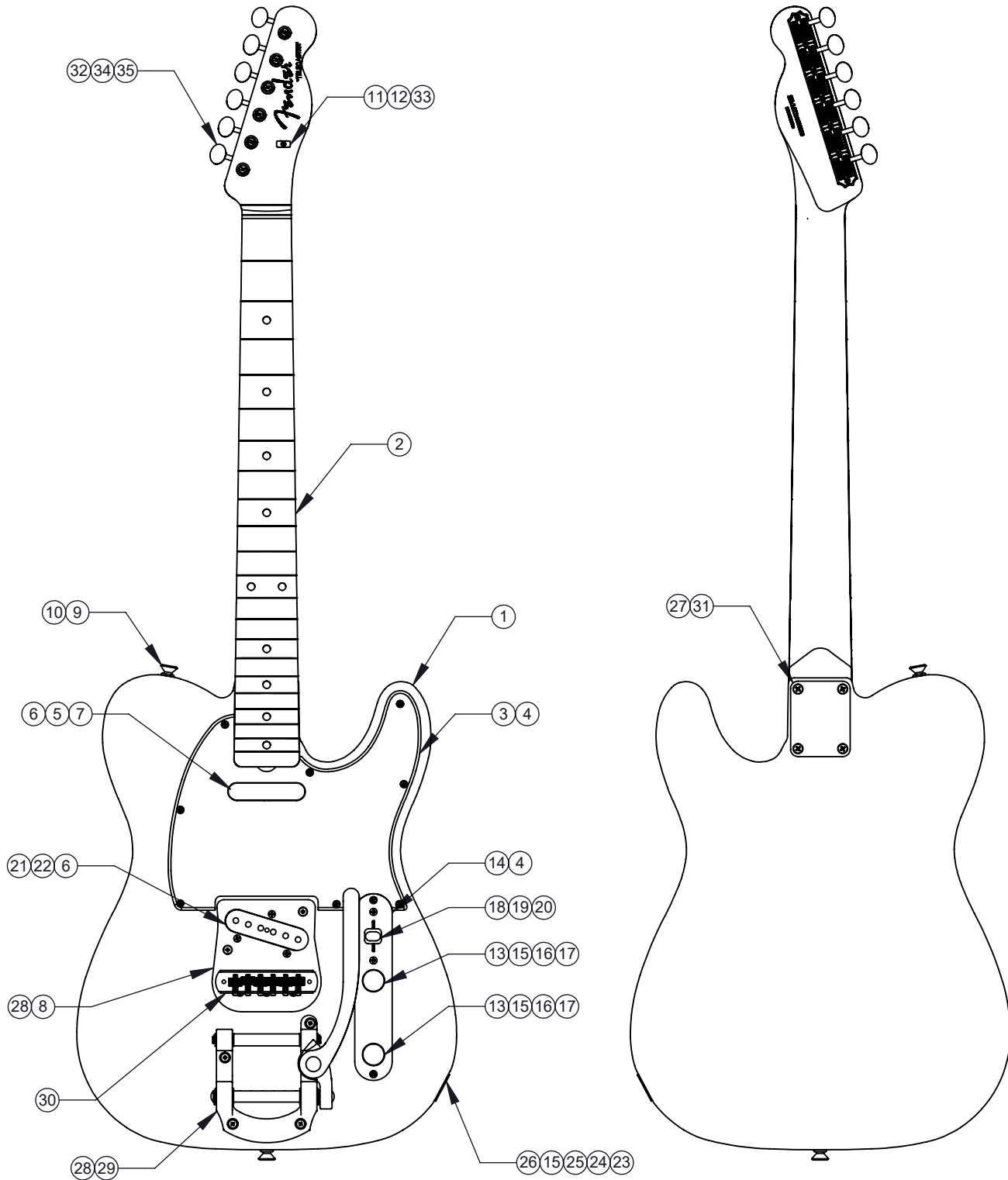

60'S TELE BIGSBY ® (014-9883-XXX)

PARTS LAYOUT

ITEM NO.	PART NUMBER	DESCRIPTION
1	7716021000	BODY 60'S TELE BIGSBY
2	7716024000	NECK 60'S TELE BIGSBY
	0061462000	PICKGUARD .090 BLK/WHT/BLK
3	0056077000	PICKGUARD .090 MG/BLK/MG
4	0015578000	SCREW SMAB 4 X 1/2 OHP NI
5	0016295000	SCREW WOOD #3 X 1 RHP STL NI
6	0039410000	TUBING LATEX CUT .250 O.D. X .125 I.D. X .550 L
7	7715929000	PICKUP ASSY SHAW 60S TELE NECK
8	7716178000	60'S TELE BIGSBY BRIDGE PU ASSY
9	0012344000	BUTTON STRAP NICKEL PLATED
10	0015610000	SCREW SMAB 5 X 1 OHP NI
11	0093569000	STRING TREE VINTAGE NI
12	0011358000	SCREW SMA #3 X 5/8 RHP STL NI
13	0019064000	CONTROL 250K 10% AUDIO METAL
14	0058383000	CONTROL ASSY MEX 60 TELE
15	0016352000	NUT HEX 3/8-32x3/32 TK NI
16	0016436000	WASHER, LOCK INTERNAL 3/8 X.675 X .035 NI
17	0013359000	KNOB KNURLED CHROME
18	0053290000	SWITCH LEVER 3 POSITION DISC GRIGSBY
19	0019448000	KNOB, SWITCH VINTAGE TELE TALL
20	0021417000	SCRW M 6-32X5/8 RHP ZA
21	7715901000	PICKUP ASSY AM VINT 64 TELE HOT BRDG
22	00993436000	SCREW TF 6-32 X 3/4 RHP STL NI
23	0037428000	JACK OUTPUT ASSY MEX TELE
24	0010355060	RETAINER JACK NI PLT (TELE)
25	0016436000	WSHR LCK INTL 3/8x.687x.035 NI
26	0021452000	FERRULE JACK STD TELE CHROME
27	0015636000	SCREW SMA 8 x 1-3/4 OHP NI
28	0016188000	SCREW WOOD 6 X 1 OHP NI
29	7709242000	BRIDGE TREMOLO BIGSBY B50 LICENSED
30	7705076000	MUSTANG BRIDGE W/THEADED SADDLES
31	0078092000	PLATE NECK VINT TELE CHR
32	0011357000	SCREW SMAB 3 X 3/8 RHP STL NI
33	0020423000	SPACER STRING TREE 62 STRAT
34	0053020000	BUSHING KEY VINT PING
35	0047912000	KEY VINT ST PING



60'S TELE BIGSBY® (014-9883-XXX)

WIRING DIAGRAM

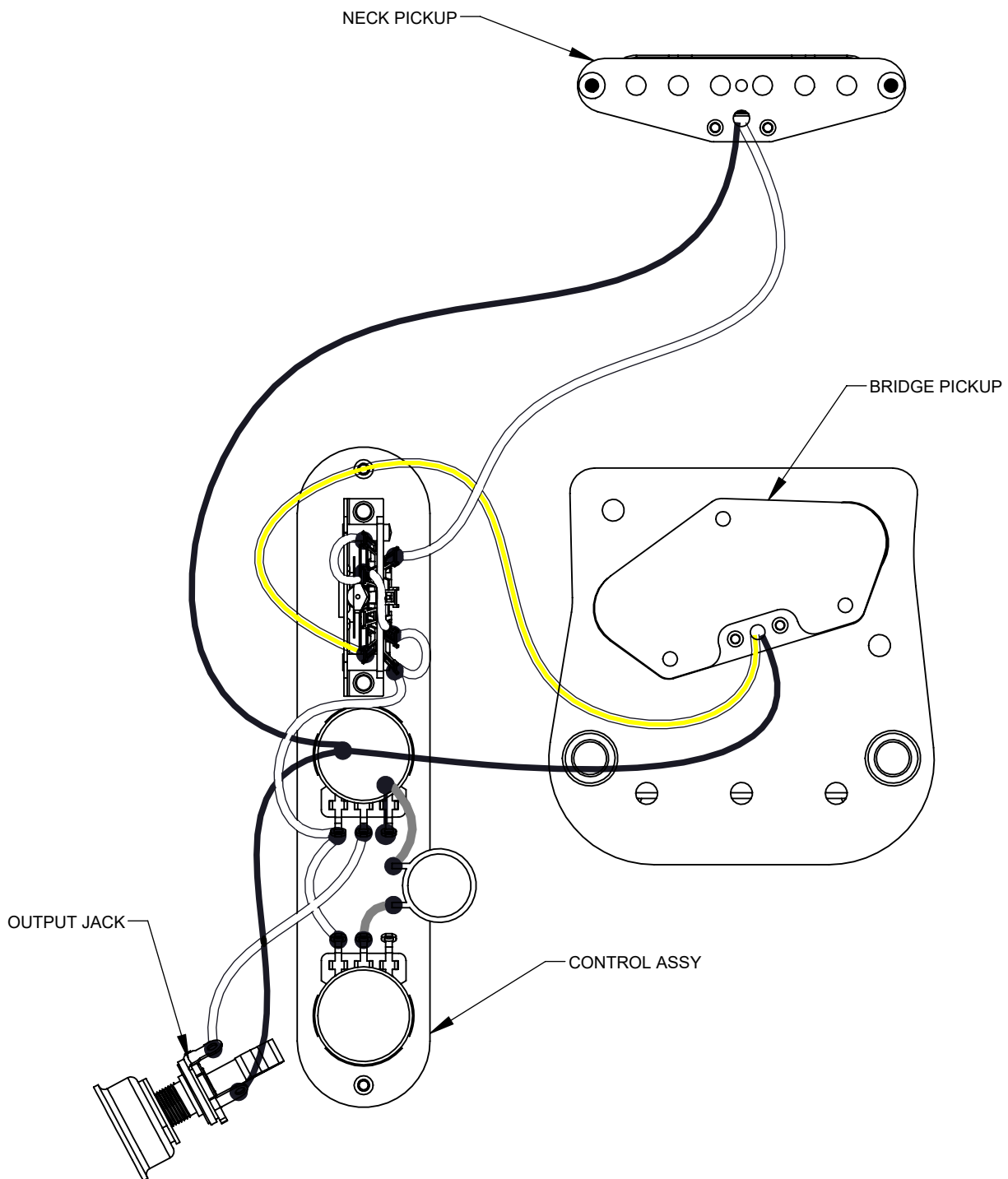

60'S TELE BIGSBY® (014-9883-XXX)

CONTROL FUNCTION

3 WAY SWITCH POSITION			SWITCH POSITION
T1	T1	T1	TONE CONTROL
			NECK PICKUP
			BRIDGE PICKUP
	PICKUP IS ON		INDICATES POSITION OF 3-WAY SWITCH
	PICKUP IS OFF		

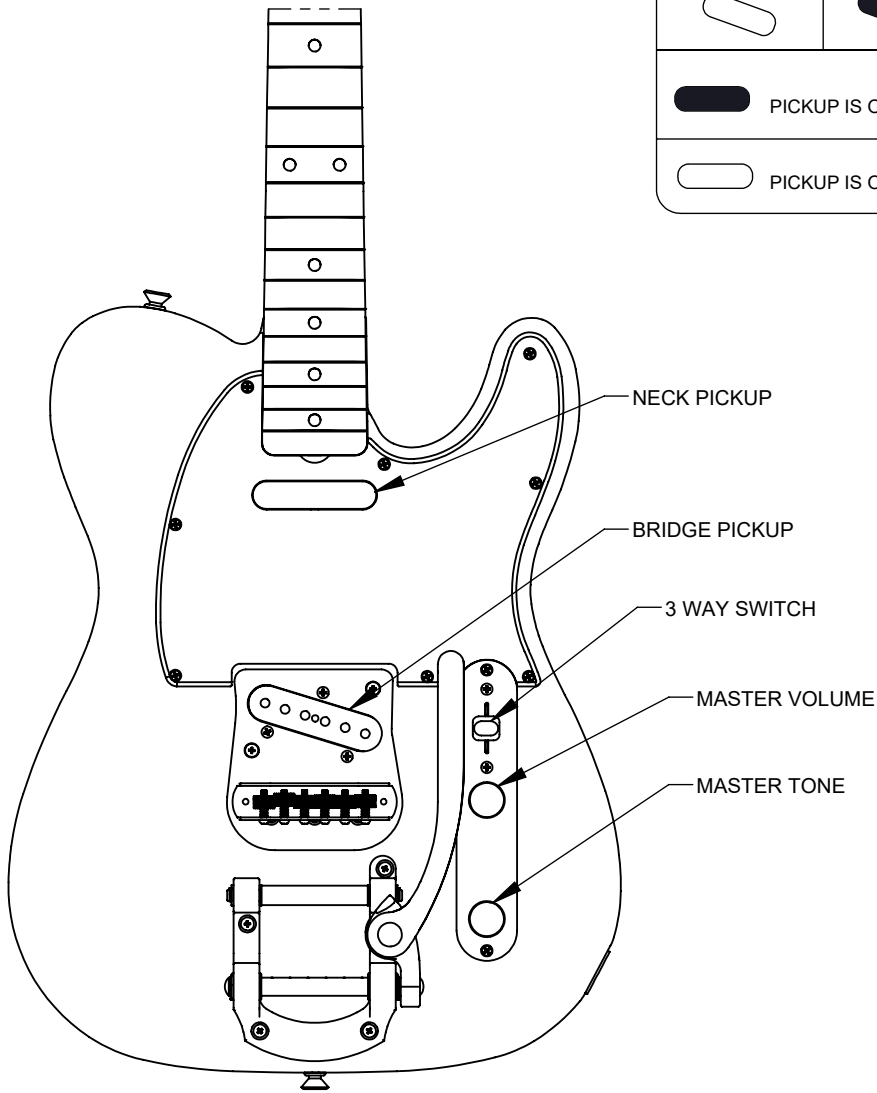

	PICKUP IS ON
	PICKUP IS OFF

60'S TELE BIGSBY ® (014-9883-XXX)

ADDITIONAL SPECIFICATION DETAIL

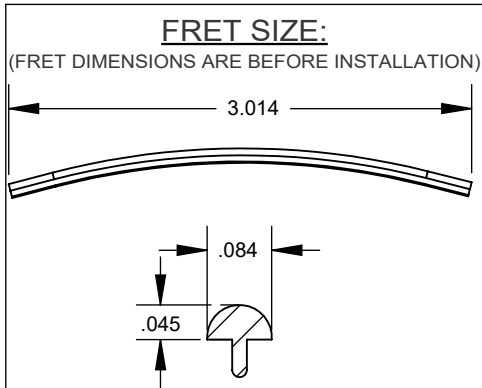

PLEASE NOTE: AS EACH NECK IS SANDED & FINISHED BY HAND, THICKNESS DIMENSIONS MAY VARY SLIGHTLY FROM THOSE SHOWN.

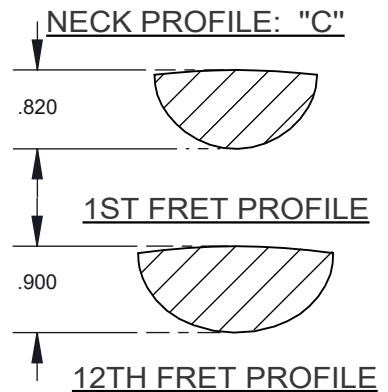

KEY ASSY VINTAGE
CHROME
P/N 0047912000

TUNING MACHINE THRU-HOLE
INNER DIAMETER .358"

BUSHING KEYS VINTAGE
PN 0053020000

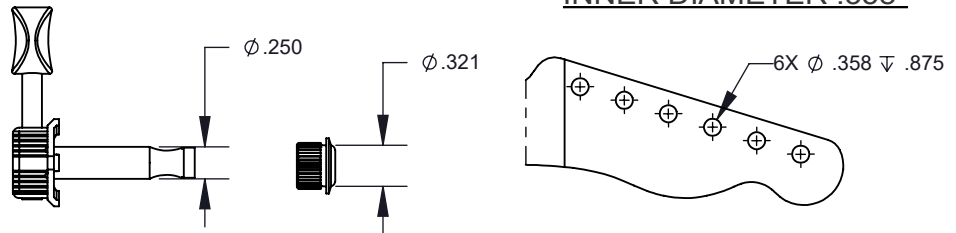

SADDLE HEIGHT ADJUSTMENT WRENCH:
HEX KEY P/N: 0018531049

TRUSS ROD NUT P/N 0012252000

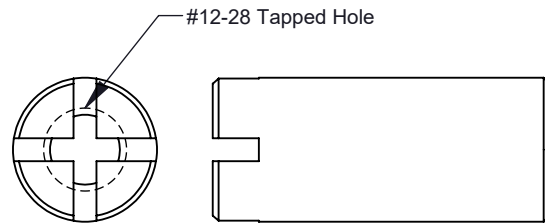
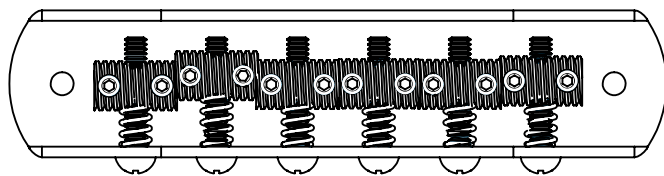

SADDLE HEIGHT ADJUSTMENT SCREW
P/N 0040800000

LOGO: DECAL MEX 60'S TELE
APPLIED UNDER THE FINISH

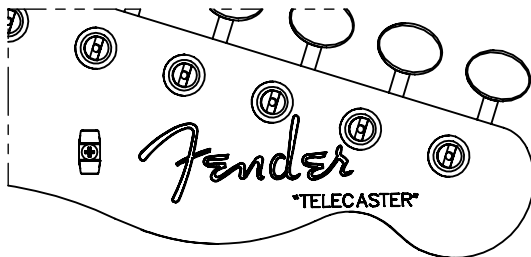

PICKUP SPECIFICATIONS

POSITION	MAGNETS	DC RESISTANCE	POLARITY
NECK	ALNICO 5 UNBEV	7.5KΩ	NORTH
BRIDGE	ALNICO 5 UNBEV	6.9 KΩ	SOUTH