

Networking for StudioLive™ Mixers Remote Control

Reference Manual



Table of Contents

1 Introduction — 1

1.1 What You Will Need — 1

1.2 Additional Resources — 1

2 Networking Basics — 3

2.1 Routers and Switches — 3

3 Adding a Computer — 5

3.1 Wired Control — 5

3.2 Wireless Control — 6

4 Adding a Tablet — 7

4.1 Connecting Your iPad to Your Network — 7

4.2 Connecting Your Android Tablet
to Your Network — 8

5 Adding a Mobile Device — 9

5.1 Connecting Your iPhone/iPod touch
to Your Network — 9

5.2 Connecting Your Android Phone
to Your Network — 10

1 Introduction

StudioLive Series III and AI-series mixers can be directly connected to a standard LAN network, so that they can be remotely controlled using UC Surface or QMix-UC. StudioLive Series III mixers can also be networked to your Mac® or Windows® computer to control Studio One Artist.

This guide will direct you through the best practices in establishing a stable control network for your StudioLive mixer as well as some networking basics to make you more comfortable troubleshooting any issues that may arise. Companion guides cover the functions of UC Surface, QMix-UC, and Studio One DAW Control Mode for StudioLive Series III mixers.

Note: While this guide discusses networking terminology and best practices, PreSonus can only provide support for networking issues that directly relate to PreSonus hardware only.

1.1 What You Will Need

In addition to your StudioLive mixer, you will need the following to network your mixer and use the companion software accessories:



Wireless Router

A wireless router is required to remote control your StudioLive mixer using UC Surface or QMix-UC for iOS® or Android™. This device allows data to flow between your mixer, tablet, mobile device, and computer with a single Ethernet cable (*more on that in Section 2.1*).

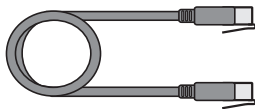

Ethernet Cable

Your mixer requires a hardwired connection to your Wireless Router. This can be acquired at most electronics dealers.



Tablet or Touch-equipped Computer (recommended for UC Surface)

PreSonus® UC Surface provides all the controls you need to mix a show without being tied to your mixer's hardware surface. It is designed to run on both Apple iPad® and Android™ tablets. Because it also runs on Windows, you can use a Windows Surface or Touch-equipped laptop to remotely control your mixer.



Mobile Device (required for QMix-UC)

QMix-UC provides performers with wireless control over their monitor (aux) mixes onstage and in the recording studio from their mobile devices. It is designed to run on both iOS and Android mobile devices.

1.2 Additional Resources

This guide covers proper networking procedures for control only. Additional reference guides are available for the following:

Hardware Guides:

- **StudioLive Series III Console Mixer Owner's Manual.** Use this reference guide to understand all the hardware functions on your StudioLive Series III console mixer (StudioLive 64S, StudioLive 32S, StudioLive 32SX, StudioLive 32SC, StudioLive 32, StudioLive 24, StudioLive 16).
- **StudioLive Series III Rackmount Mixer Owner's Manual.** Use this reference guide to understand all the hardware functions on your StudioLive Series III rackmount mixer (StudioLive 32R, StudioLive 24R, StudioLive 16R).
- **StudioLive AI-Series Console Mixer Owner's Manual.** Use this reference guide to understand all the hardware functions on your StudioLive AI-Series console mixer (StudioLive 32.4.2AI, StudioLive 24.4.2AI, StudioLive 16.4.2AI).
- **StudioLive AI-Series Rackmount Mixer Owner's Manual.** Use this reference guide to understand all the hardware functions on your StudioLive AI-Series rackmount mixer (StudioLive RM/RML32, StudioLive RM/RML16).

Software Guides:

- **Capture 3 Reference Manual.** Included with StudioLive mixers is Capture, a digital-audio multitrack-recording application designed to make recording quick and easy.
- **QMix-UC Reference Manual.** This guide describes the features and functions of QMix-UC with every StudioLive mixer model. QMix-UC lets up to 16 users remotely control the Aux Mixes on your StudioLive using their smartphone.
- **Studio One Integration Reference Manual.** Studio One Artist is included with every StudioLive mixer. In addition to being a powerful DAW, Studio One provides unique routing and integration features. This manual will help you get the most from your StudioLive mixer when used with Studio One or Studio One Artist.
- **UC Surface Reference Manual.** This guide describes the features and functions of UC Surface with every StudioLive mixer model. UC Surface can be used to remotely control every function on your StudioLive mixer or specific functions, depending on the set permissions, or to turn your tablet into additional screens for your mixer.
- **Using Your StudioLive as an Audio Interface with Universal Control Reference Guide.** This guide describes the features and functions Universal Control as well as how to use your StudioLive mixer as an audio interface with your favorite DAW application.

Additional Resources:

- **StudioLive Series III AVB Networking Guide.** This manual covers advanced AVB audio networking configuration for the StudioLive Series III mixers.
- **StudioLive Series III Stage box Mode Addendum.** The StudioLive Series III rackmount mixers (StudioLive 32R, StudioLive 24R, StudioLive 16R) can be used as advanced stageboxes for StudioLive Series III console mixers (StudioLive 32, StudioLive 24, StudioLive 16).
- **StudioLive Series III Studio One DAW Control Addendum.** StudioLive Series III console mixers (StudioLive 32, StudioLive 24, StudioLive 16) can be used to control Studio One and Studio One Artist.

2 Networking Basics

At its core, a network is created when two or more devices (computers, iPads, Android devices, networkable mixers) intelligently share data between one another. In the case of the StudioLive mixers and their companion software, this is control data. A network can be as simple as a single StudioLive mixer connected to an iPad via a wireless router.

The type of network employed by StudioLive mixers is called a Local Area Network or LAN. This type of network is formed by devices within a reasonably close proximity to one another (i.e., same house, same office, or same campus).

Please note: that while some of the information in this section applies to standard LAN networks that do not include a StudioLive mixer, this section describes requirements and best practices regarding configuring a control network for your StudioLive mixer only.

Below are some common terms you may encounter when purchasing and configuring your control network:

- **Node.** A node is any device connected to a network. This could be a computer, an iOS or Android device, your mixer, etc.
- **Segment.** This is any part of the network that is separated from other parts of the network by a router, switch, or bridge.
- **Topology.** The topology describes the way in which each node connects to the network.
- **Media Access Control (MAC) Address.** This is the physical address of any node on the network. This string of numbers identified the manufacturer and the serial number of each node's Network Interface Card or NIC.

2.1 Routers and Switches

When connecting multiple nodes a standard LAN network, you can usually choose to use either a hub, a switch, a router, or some combination thereof. For StudioLive control networks, you must use a router. If your router has an integrated switch and you require additional Ethernet ports, you can connect a switch to your router, more on that in a minute.

The most common form of routers on the market today are wireless. While there are such devices as wired routers, they are not very common. PreSonus requires a high-quality wireless router to use mobile devices and tablets, however, you also have the option of connecting your computer wirelessly for both UC Surface use and Studio One control if you would prefer this method over hardwiring your computer to your router.

Let's take a look at the following simple network:

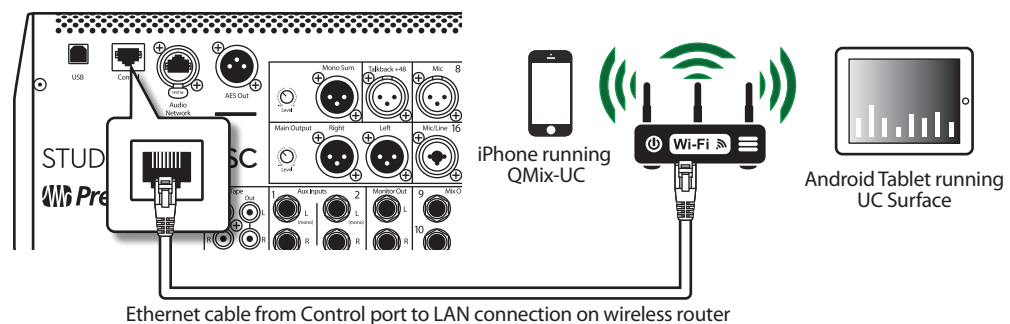

In this example, we have a StudioLive 32SC, an Android tablet, and an iPhone all communicating with one another through a wireless router with an integrated switch. The StudioLive 32SC is connected to the wireless router via its Control port using an Ethernet LAN connection on the integrated switch. The tablet and the iPhone are connected wirelessly.

While you'd never notice this empirically, the router is communicating to each device one at a time in small data packets. It takes the data packet from the Source Address and sends it to the Destination Address. These addresses are derived from the Internet Protocol (IP) Addresses of each device on the network. In most cases, these IP Addresses are assigned dynamically by the router using the DHCP protocol, however most devices, including the StudioLive mixers support Static Self-Assigned and Manual addressing. ***Please review the Universal Control and UC Surface Reference Guide for more information.***

The router's job is to keep track of these data packets and route them to and from the appropriate IP address.

By contrast, a network switch acts as a controller so that information flows more efficiently between devices on a network. In the simplest terms, a switch creates a network and routers act as the dispatcher, selecting the best path for the information to travel.

Power User Tip: When connecting your mixer to your router, you may find both LAN and WAN ports. WAN ports are sometimes labeled 'Internet'. This port is firewalled and designed to communicate with Internet Service Providers (ISPs). PreSonus recommends only using the LAN ports on your router.

3 Adding a Computer

There are three great reasons to network your computer to your StudioLive mixer:

- **UC Surface.** UC Surface can be used as a second screen for your mixer, you can also back-up and organize scenes and presets.
- **Capture.** When the computer running Capture is networked to your StudioLive, you can save and recall your StudioLive mix scenes with your Capture audio as well as remote control your mixer's digital returns for Virtual Soundcheck.
- **Studio One.** Networking your StudioLive Series III console mixer to Studio One allows you to use it as a control surface. Additional integration features are also available. *Please review the Studio One StudioLive Integration Reference Guide for more information.*

3.1 Wired Control

Hardwiring both your mixer and your computer to the same router is the easiest configuration:

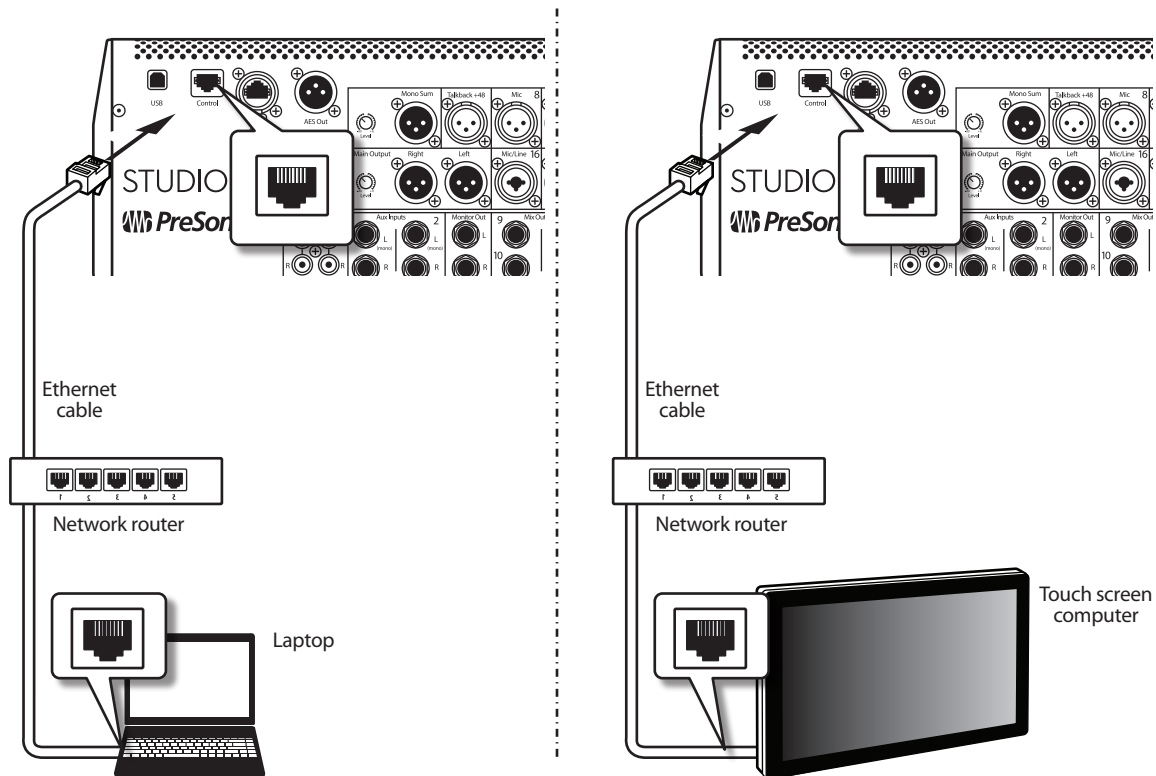

Connect standard CAT5e or CAT6 Ethernet cables from your computer's Ethernet port to LAN port on an Ethernet router, and from the router to the Control port on the StudioLive's rear panel as depicted above.

To verify proper connectivity, launch Universal Control and verify that your StudioLive mixer appears in the device list.

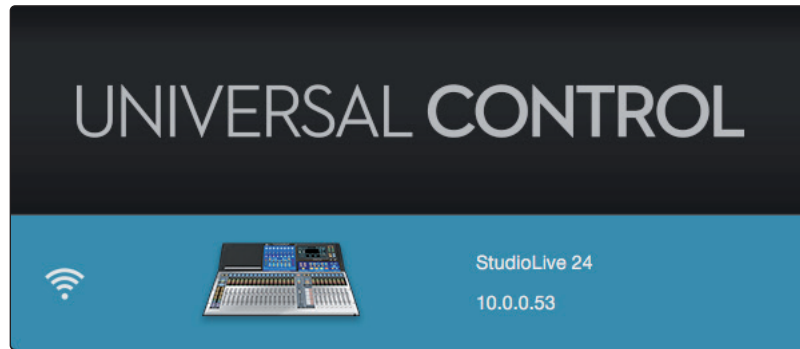

NOTE: UCNET doesn't support dual network connections. If your computer is hardwired to the same router as your mixer, you must disable its wireless connection (if applicable).

3.2 Wireless Control

Using a wireless router allows you to remote control your mixer without any additional cabling.

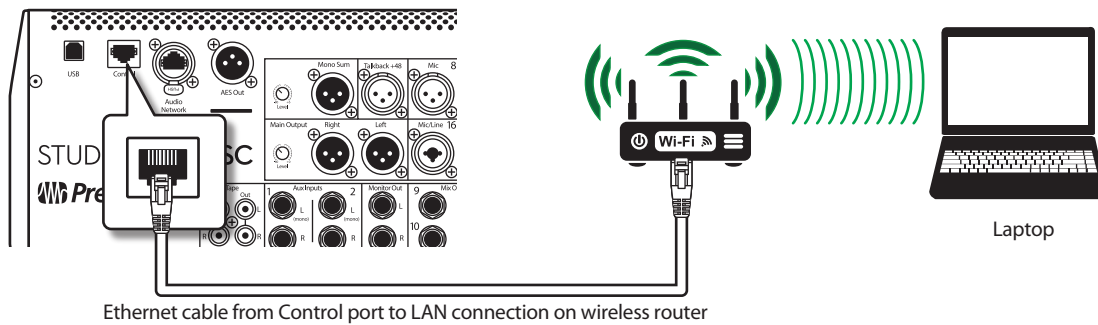

Connect your mixer and your computer to your router as shown above. Make sure you are connecting the Control port of your mixer to a LAN port on your router. To connect your computer wirelessly to your router:

Windows 7+

1. Click on the network icon in the notification area to open the Connect to Network Control Panel.
2. Select the name of the wireless network you set for your wireless router.
3. Enter the password.
4. Click Connect.

macOS 10.8 and later

1. On the Menu bar click on the Wireless Status icon.
2. Select the name of the wireless network you set for your wireless router.
3. Enter the password.
4. Click Join

Power User Tip: In some cases, your router is too far from your mixer and your computer to connect them both. This is where Access Points can come in handy. These devices allow you to extend your wireless network and provide additional connectivity.

4 Adding a Tablet

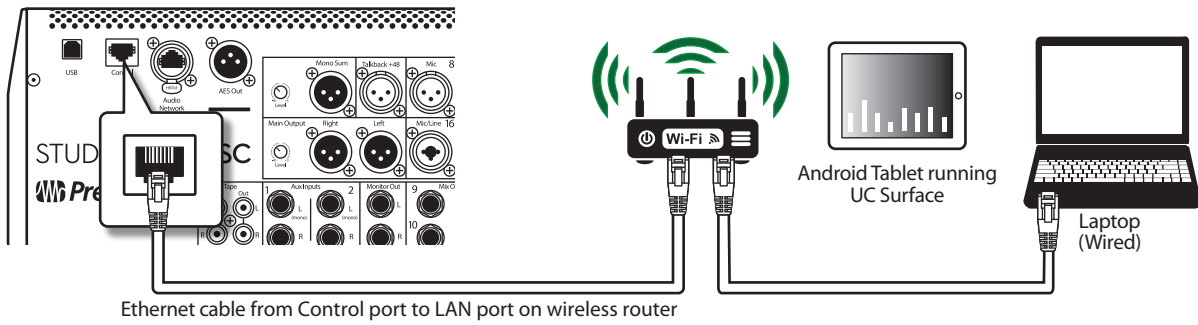

4.1 Connecting Your iPad to Your Network



1. Tap on the Settings icon in your iPad.

2. Tap on "Wi-Fi."

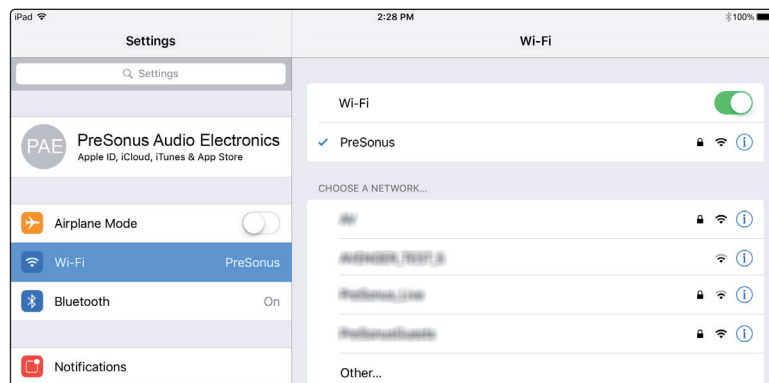

3. Select the network to which your StudioLive is connected and enter the password when prompted. Tap Join.

4. Enter the password when prompted and tap Join.

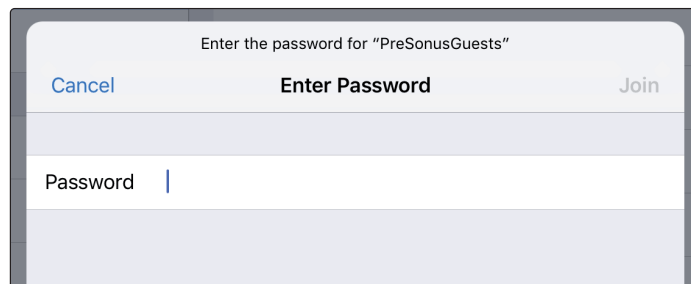

4.2 Connecting Your Android Tablet to Your Network

1. Tap on the System Settings icon.
2. Tap on "Wi-Fi."
3. Select the network to which your StudioLive is connected and enter the password when prompted. Tap Join.
4. Enter the password when prompted and tap Join

5 Adding a Mobile Device

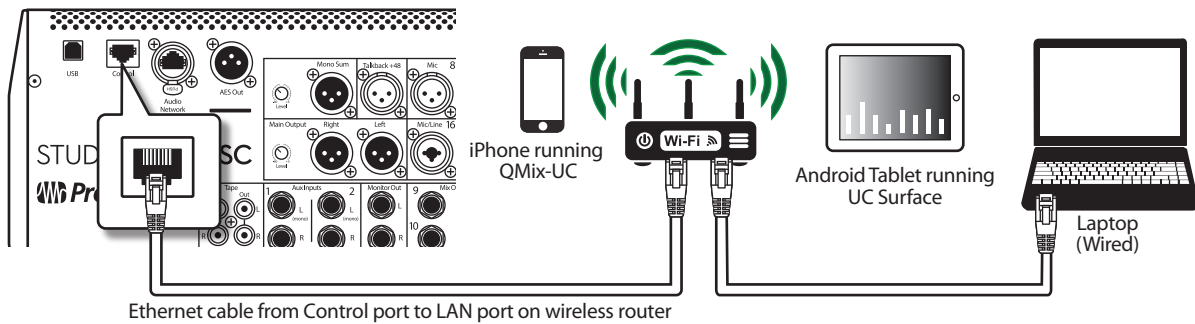

5.1 Connecting Your iPhone/iPod touch to Your Network



1. Tap on the Settings icon in your iPhone/iPod touch.

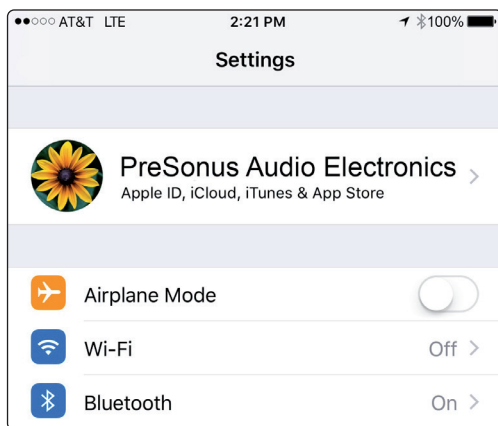

2. Tap on "Wi-Fi" making sure it is set to "On."

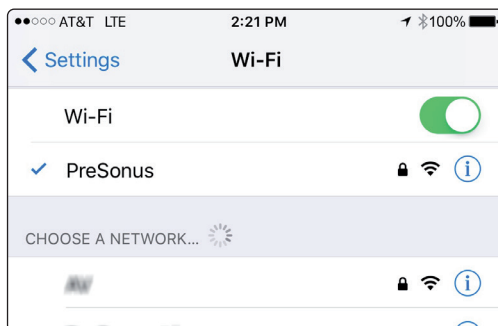

3. Under "Choose a Network," select the same network you saved on your StudioLive from the list.

4. Tap on the network to select it.

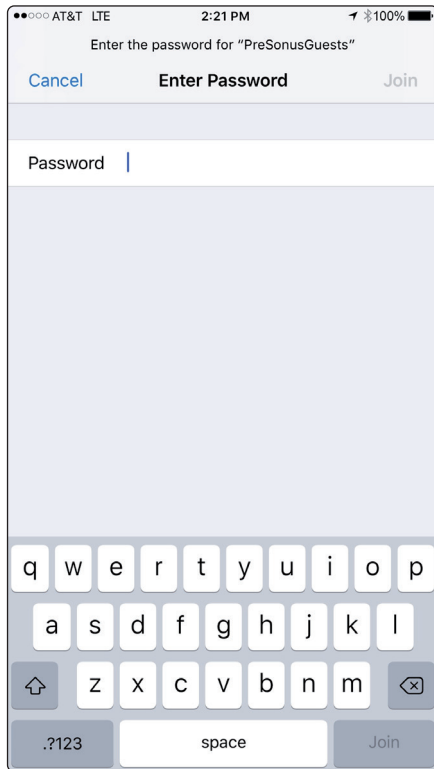

5. Enter the password when prompted and tap Join.

Important: You must connect your computer and iOS devices to the same network as your StudioLive mixer each time you plan on remote-controlling your StudioLive with UC Surface, or QMix-UC.

5.2 Connecting Your Android Phone to Your Network

1. Tap on the System Settings icon.
2. Tap on "Wi-Fi."
3. Select the network to which your StudioLive is connected and enter the password when prompted. Tap Join.
4. Enter the password when prompted and tap Join

Added bonus: PreSonus' previously Top Secret recipe for...

Redfish Couvillion

Ingredients:

- ¼ C Vegetable oil
- ¼ C flour
- 1 onion diced
- 1 clove garlic minced
- 1 green pepper diced
- 3 celery stalks diced
- 1 14oz can diced tomatoes
- 1 bottle light beer
- 2 bay leaves
- 1 tsp thyme
- 2 lbs Redfish fillets

Cooking Instructions:

1. In a heavy saucepan or large skillet, heat oil on medium high and slowly add flour a tablespoon at a time to create a roux. Continue cooking the roux until it begins to brown, creating a dark blond roux.
2. Add garlic, onions, green pepper, and celery to roux.
3. Sauté vegetables for 3-5 minutes until they start to soften.
4. Add tomatoes, bay leaves, thyme, and redfish. Cook for several minutes.
5. Slowly add beer and bring to a low boil.
6. Reduce heat and simmer uncovered for 30-45 minutes until redfish and vegetables are completely cooked, stirring occasionally. Break up redfish into bite size chunks and stir in. Add pepper or hot sauce to taste. Do not cover.
7. Serve over rice

Serves 6-8

While not one of Southeast Louisiana's more famous dishes, Redfish Couvillion is a favorite way to serve our favorite Gulf fish. Also known as Reds or Red Drum, Redfish is not only fun to catch, it's also delicious!



Networking for StudioLive™ Mixers Remote Control

Reference Manual

